

# FINA TEHNO LED

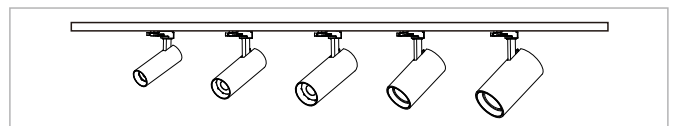

## ries

1070 pure aluminum  
4 installations, 5 sizes

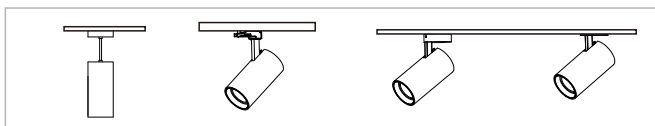

**FINA TEHNO LED**

JURIJA GAGARINA 192/24  
11070 NOVI BEOGRAD  
SRBIJA

TEL : +381 11 215 2232  
MOB: +381 62 355 896  
MOB: +381 62 355 894

E - MAIL : [office@finatehnoled.com](mailto:office@finatehnoled.com)  
WEB : [www.finatehnoled.com](http://www.finatehnoled.com)

### Common radiator in the market

ADC12 die-casting one-part aluminum radiator, The index of thermal conductivity : 96W/(m\*k)



Al6063 aluminum housing + radiator, The index of thermal conductivity : 209W/(m\*k)



Al6063 one-part aluminum radiator, The index of thermal conductivity : 201W/(m\*k)



### 1070 aluminum radiator of TOMI series

Adopted the cold forging process, the radiator and the lamp housing are intergrated, which make the heat dissipation area maximized. With ultra-high thermal conductivity of 236W/m\*k, 1070 pure aluminum material can quickly dissipate heat. On the other hand, 1070 pure aluminum can realize more complicated surface spraying process, such as painting, powder coating, oxidation, and electroplating.

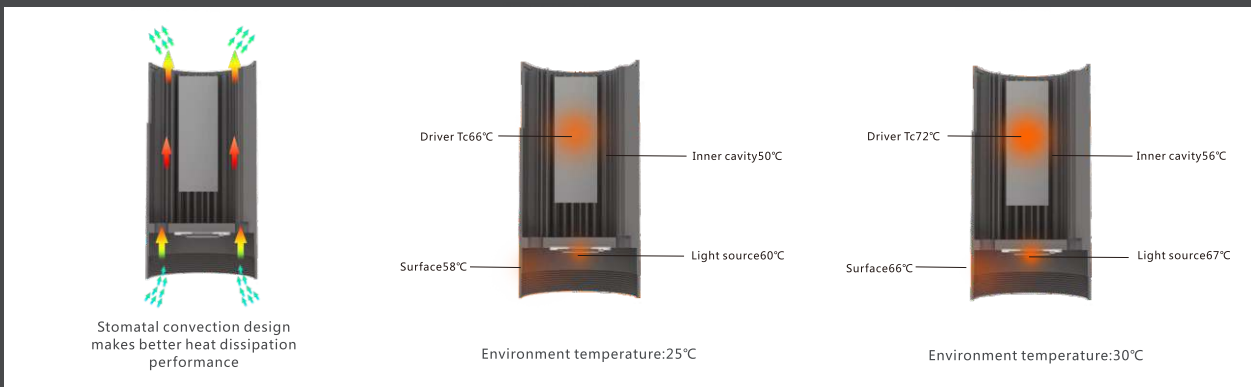

Forging Process/Material	The index of thermal conductivity	Heat dissipation performance	Advantage / disadvantage
Die casting/ ADC12 aluminum	96W/(m*k)	poor	The radiator is integrated with the housing. However, the thermal conductivity of ADC12 material is too low to dissipate the heat in time.
Aluminium housing+ radiator /AL6063	209W/(m*k)	good	The radiator is not integrated with the housing. The heat is mainly dissipated through the radiator, and the heat dissipation area is insufficient.
Extrusion / AL6063	209W/(m*k)	excellent	The radiator is integrated with the housing. With high thermal conductivity, 6063 aluminum material can dissipate the heat in time. But CNC machining cost is high, aluminum is wasted a lot, and the cost is high.
Cold forge/1070 aluminum	236W/(m*k)	excellent	The radiator is integrated with the housing. With high thermal conductivity, 1070 pure aluminum material can quickly dissipate the heat. Besides, low CNC machining cost, less aluminum waste make the cost competitive.

**Power options: 8w-32w**

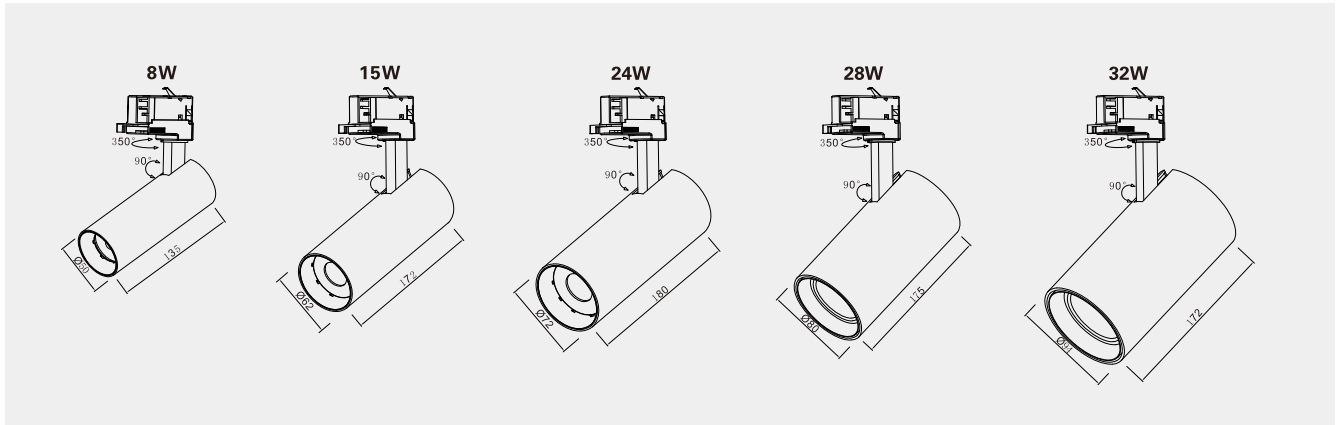

**Four installation ways**

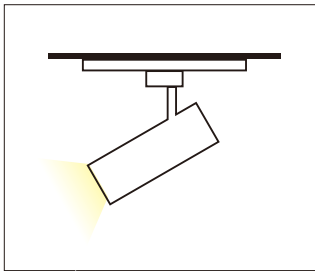

Track mounted

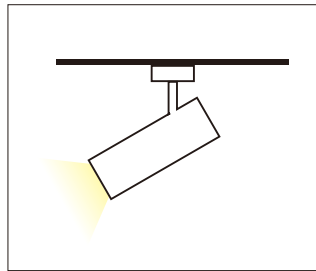

Ceiling mounted

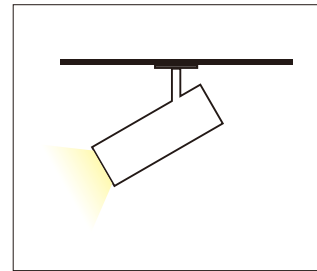

Recessed mounted

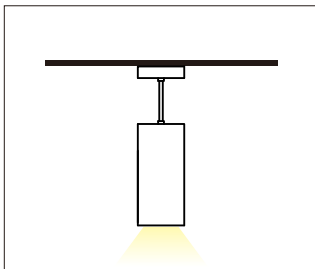

Suspended mounted

# STAR LENS



Model.

SW-TL08-051  
SW-TL15-053  
SW-TL24-054  
SW-TL28-055  
SW-TL32-056

Power.

8W  
15W  
24W  
28W  
32W



- Matt White
- Silver
- Matt Black

- 17°
- 24°
- 33°
- 40°

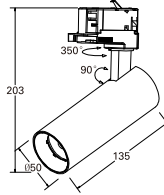

## SW-TL08-051

Luminaire Power	LED Power	CRI	Flux	CCT	Beam	Driver Current
8W	6.5W	80	670lm	3000K	17°	DC 180mA
8W	6.5W	80	686lm	3000K	24°	DC 180mA
8W	6.5W	80	659lm	3000K	33°	DC 180mA
8W	6.5W	80	697lm	3000K	40°	DC 180mA
8W	6.5W	90	634lm	3000K	17°	DC 180mA
8W	6.5W	90	627lm	3000K	24°	DC 180mA
8W	6.5W	90	618lm	3000K	33°	DC 180mA
8W	6.5W	90	658lm	3000K	40°	DC 180mA

17° 8W / 3000K / Ra80

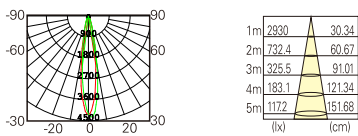

24° 8W / 3000K / Ra80

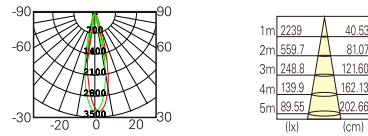

33° 8W / 3000K / Ra80

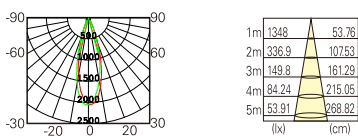

40° 8W / 3000K / Ra80

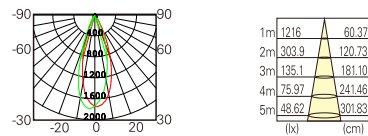

17° 8W / 3000K / Ra90

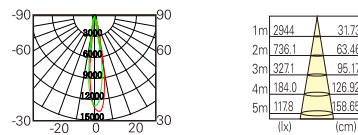

24° 8W / 3000K / Ra90

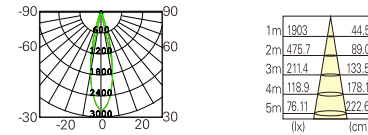

33° 8W / 3000K / Ra90

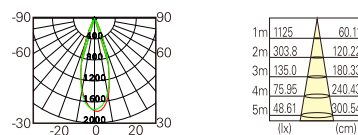

40° 8W / 3000K / Ra90

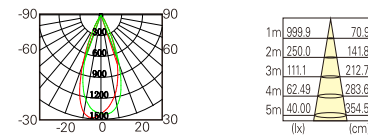

Detailed parameters please refer to products specification



- Matt White
- Silver
- Matt Black

- 17°
- 24°
- 33°
- 40°

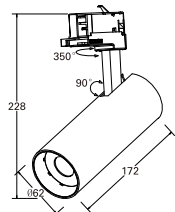

## SW-TL15-053

Luminaire Power	LED Power	CRI	Flux	CCT	Beam	Driver Current
15W	12.6W	80	1455lm	3000K	17°	DC 350mA
15W	12.6W	80	1462lm	3000K	24°	DC 350mA
15W	12.6W	80	1518lm	3000K	33°	DC 350mA
15W	12.6W	80	1414lm	3000K	40°	DC 350mA
15W	12.6W	90	1196lm	3000K	17°	DC 350mA
15W	12.6W	90	1199lm	3000K	24°	DC 350mA
15W	12.6W	90	1250lm	3000K	33°	DC 350mA
15W	12.6W	90	1180lm	3000K	40°	DC 350mA

15° 15W / 3000K / Ra80

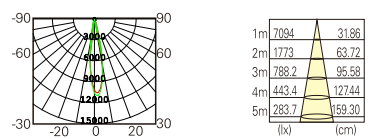

24° 15W / 3000K / RA80

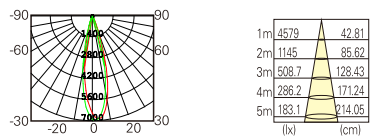

36° 15W / 3000K / Ra80

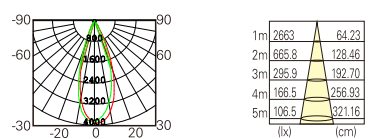

50° 15W / 3000K / Ra80

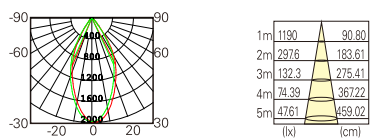

15° 15W / 3000K / Ra90

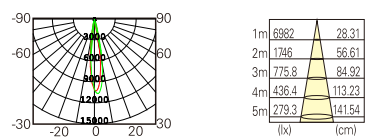

24° 15W / 3000K / Ra90

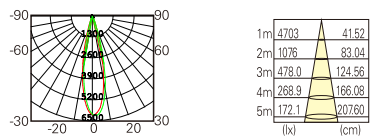

36° 15W / 3000K / Ra90

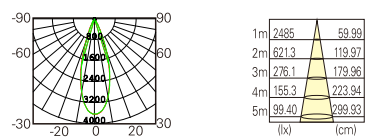

50° 15W / 3000K / Ra90

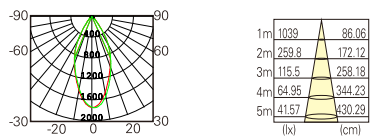

Detailed parameters please refer to products specification



- Matt White
- Silver
- Matt Black

- 15°
- 27°
- 31°
- 55°

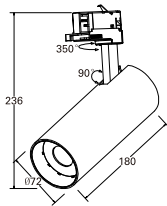

## SW-TL24-054

Luminaire Power	LED Power	CRI	Flux	CCT	Beam	Driver Current
24W	21.6W	80	2279lm	3000K	15°	DC 600mA
24W	21.6W	80	2457lm	3000K	27°	DC 600mA
24W	21.6W	80	2644lm	3000K	31°	DC 600mA
24W	21.6W	80	2241lm	3000K	55°	DC 600mA
24W	21.6W	90	1198lm	3000K	15°	DC 600mA
24W	21.6W	90	2105lm	3000K	27°	DC 600mA
24W	21.6W	90	2244lm	3000K	31°	DC 600mA
24W	21.6W	90	1935m	3000K	55°	DC 600mA

15° 24W / 3000K / Ra80

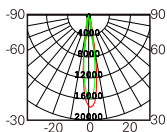

1m	1192.7	24.98
2m	2982	49.97
3m	1325	74.95
4m	745.5	99.94
5m	477.1	124.92

27° 24W / 3000K / Ra80

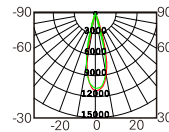

1m	765.4	46.66
2m	1914	93.73
3m	850.5	140.59
4m	478.4	187.45
5m	306.2	234.32

31° 24W / 3000K / Ra80

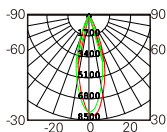

1m	515.1	54.89
2m	1288	109.78
3m	572.4	164.68
4m	321.9	219.57
5m	206.0	274.46

55° 24W / 3000K / Ra80

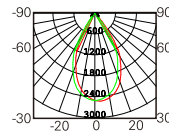

1m	1506	109.18
2m	376.5	218.35
3m	167.3	327.53
4m	94.13	436.70
5m	60.24	545.88

15° 24W / 3000K / Ra90

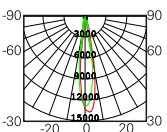

1m	887.1	28.22
2m	2218	56.43
3m	985.7	84.65
4m	554.4	112.86
5m	354.8	141.08

27° 24W / 3000K / Ra90

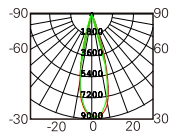

1m	6370	48.06
2m	1592	96.12
3m	707.7	144.18
4m	398.1	192.24
5m	254.8	240.30

31° 24W / 3000K / Ra90

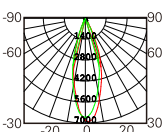

1m	4375	53.89
2m	1094	107.79
3m	496.1	161.68
4m	273.4	215.58
5m	175.0	269.47

55° 24W / 3000K / Ra90

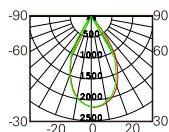

1m	1301	108.43
2m	325.2	216.86
3m	144.5	325.29
4m	81.29	433.71
5m	52.03	542.14

Detailed parameters please refer to products specification



- Matt White
- Silver
- Matt Black

- 15°
- 24°
- 36°
- 60°

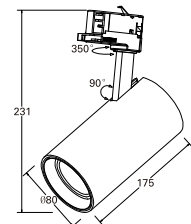

## SW-TL28-055

Luminaire Power	LED Power	CRI	Flux	CCT	Beam	Driver Current
28W	25.2W	80	2847lm	3000K	15°	DC 700mA
28W	25.2W	80	2957lm	3000K	24°	DC 700mA
28W	25.2W	80	2825lm	3000K	36°	DC 700mA
28W	25.2W	80	2685lm	3000K	60°	DC 700mA
28W	25.2W	90	2203lm	3000K	15°	DC 700mA
28W	25.2W	90	2486lm	3000K	24°	DC 700mA
28W	25.2W	90	2351lm	3000K	36°	DC 700mA
28W	25.2W	90	2322m	3000K	60°	DC 700mA

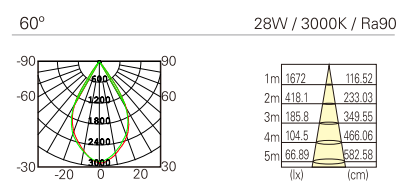
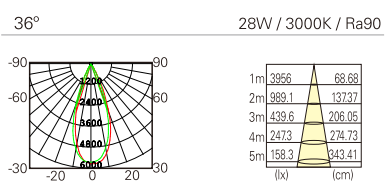
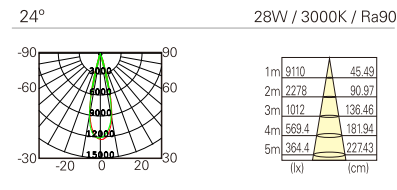
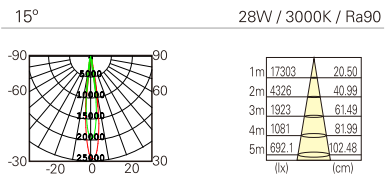
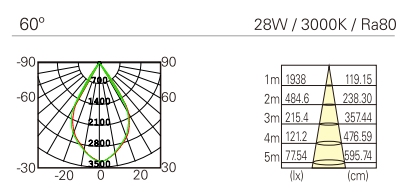
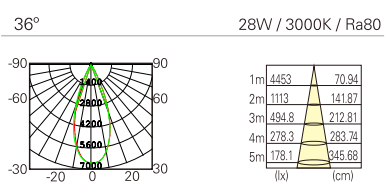
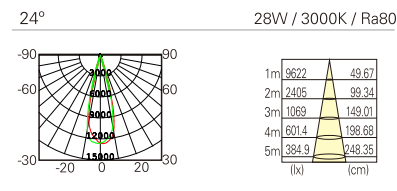
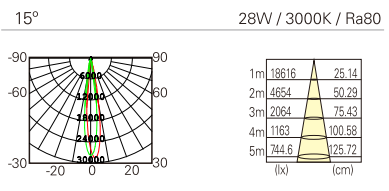

Detailed parameters please refer to products specification



- Matt White
- Silver
- Matt Black

- 15°
- 24°
- 40°
- 55°

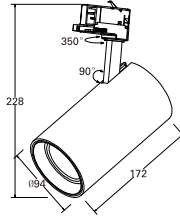

## SW-TL32-056

Luminaire Power	LED Power	CRI	Flux	CCT	Beam	Driver Current
32W	28.8W	80	3351lm	3000K	15°	DC 800mA
32W	28.8W	80	3485lm	3000K	24°	DC 800mA
32W	28.8W	80	3485lm	3000K	40°	DC 800mA
32W	28.8W	80	3038lm	3000K	55°	DC 800mA
32W	28.8W	90	2577lm	3000K	15°	DC 800mA
32W	28.8W	90	2456lm	3000K	24°	DC 800mA
32W	28.8W	90	2667lm	3000K	40°	DC 800mA
32W	28.8W	90	2353m	3000K	55°	DC 800mA

15° 32W / 3000K / Ra80

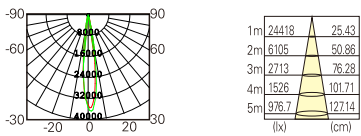

24° 32W / 3000K / Ra80

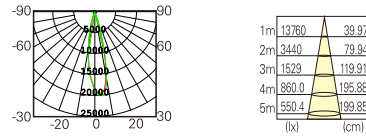

40° 32W / 3000K / Ra80

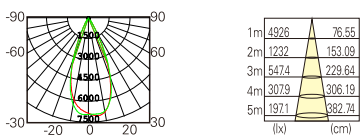

55° 32W / 3000K / Ra80

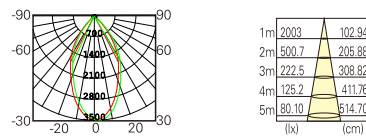

15° 32W / 3000K / Ra90

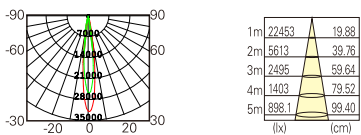

24° 32W / 3000K / Ra90

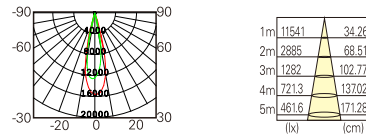

40° 32W / 3000K / Ra90

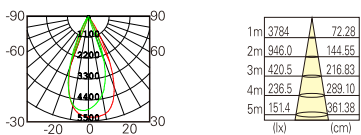

55° 32W / 3000K / Ra90

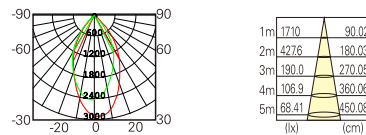

Detailed parameters please refer to products specification