



Silicone Neon Strip

Silicone Neon Strip, is made by adopting dual-color silicone integrated extrusion shaping process, and its protection grade reaches up to IP67/IP68, featuring resistances to saline solutions, acid & alkali, corrosive gases, fire and UV, applying to indoor and outdoor molding decoration, building outlines, city night scenes illuminating and so forth for the sake of the effect of decorative lighting.

Flat luminous surface series

- Adopt SMD2835 LEDs with high luminous efficiency, the higher brightness, homogeneous lighting, LM80 proved, quality guaranteed;
- Adopt environmental silicone material, fabricated by the integrated silicone extrusion molding, features good resistance of saline solutions, acid & alkali, corrosive gases, fire and UV, IP grade up to IP65/IP67/IP68;
- The Planar Neon Series lighting softly and smoothly, suitable for recessed installation and surface mounting, features complete, systematic installation solution;
- Widely used for indoor decoration, landscape lighting, building exterior structure and swimming pool;
- Outstanding weather resistance makes it in a normal-soft state at -20°C \sim $+45^{\circ}\text{C}$;
- Passed UL、CE、Rohs certification, 3 years warranty, life span over 36000 hours.

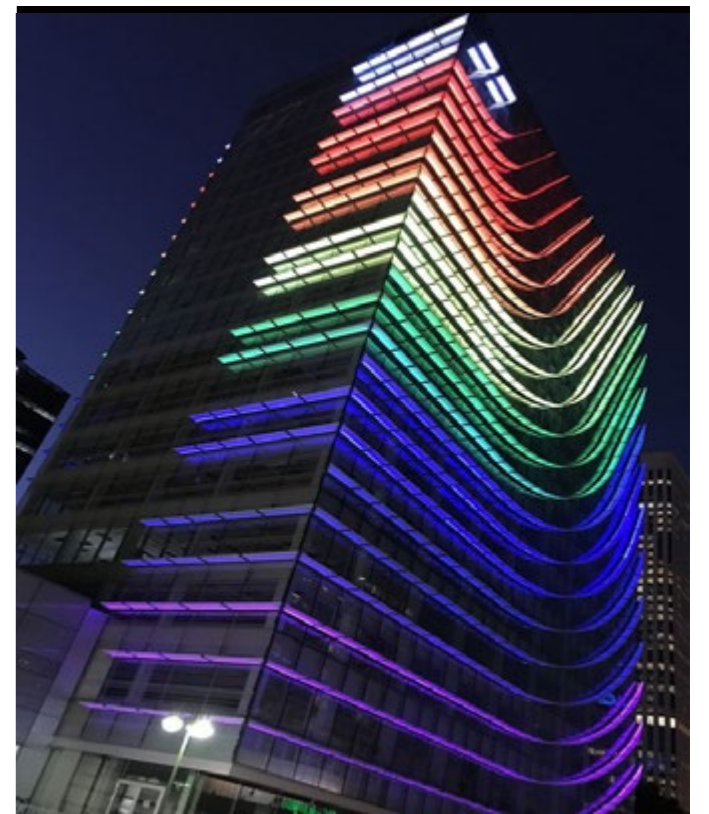

Curve luminous surface series

- Adopt SMD2835 LEDs with high luminous efficiency, the higher brightness, homogeneous lighting, LM80 proved, quality guaranteed;
- Adopt environmental silicone material, fabricated by the integrated silicone extrusion molding, features good resistance of saline solutions, acid & alkali, corrosive gases, fire and UV, IP grade up to IP67/IP68;
- Ultra long constant-current design, 50 meters LED strip driven by one end power supply with the same brightness ;
- The Cambered Neon Series, with unique optical design, features homogeneous and soft lighting, 160° large luminous surface, suitable for the recessed installation and surface mounting;
- Widely used for indoor decoration, landscape lighting, building exterior structure and swimming pool; Outstanding weather resistance makes it in a normal-soft state at -20° C--+45° C; Passed UL、CE、
- Rohs certification, 3 years warranty, life span over 36000 hours.

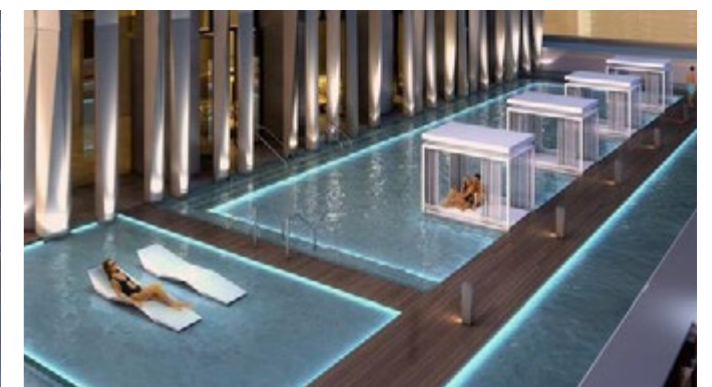
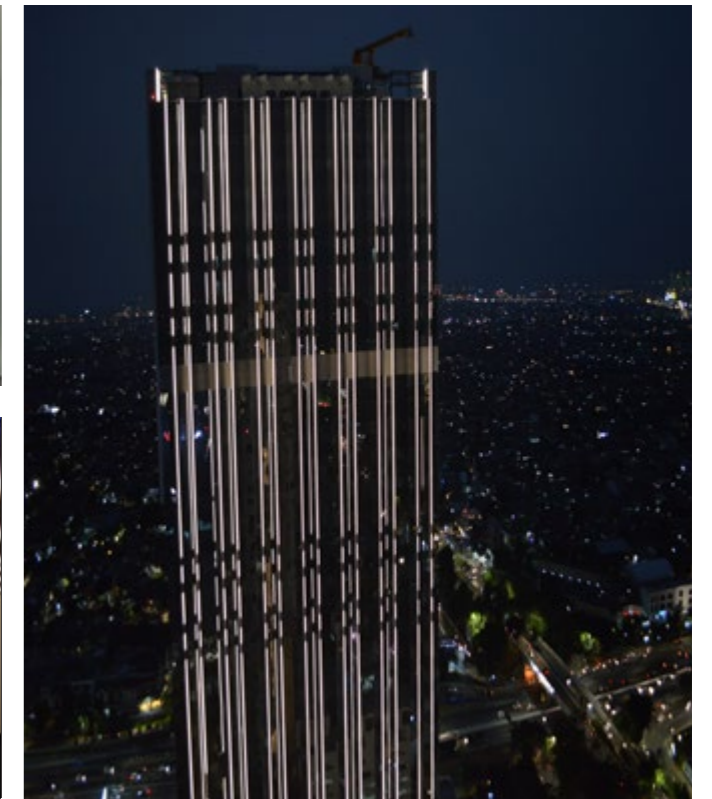

Product List

Series	Flat luminous surface series (Side bend)
Model	NTS0410
Size (mm)	5000×04×10
White light	12/24VDC
Min cut (mm)	17.86/41.66
Max.power (W/m)	8
Typ.power (W/m)	7.2
Lumens (LM/m)	240/290/300/300
CCT / Color	
CRI	>80/90
Min bending radius (mm)	>30
IP	IP65

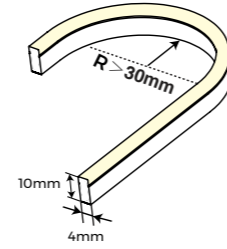

Series	Flat luminous surface series (Side bend)
Model	NMS0612
Size (mm)	White light/R/G/B/Y : 5000×6×12
White light	12/24VDC
Min cut (mm)	25/50
Max.power (W/m)	10.6 (White light) ; 8.8(RGBY)
Typ.power (W/m)	9.6 (White light) ; 8(RGBY)
Lumens (LM/m)	230/240/240/220/240
CCT / Color	
CRI	>80/90
Min bending radius (mm)	>30
IP	IP67

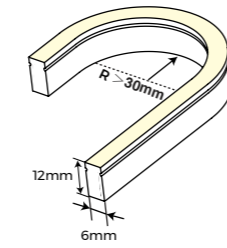

Series	Flat luminous surface series (Side bend)
Model	NMS1020
Size (mm)	5000x10x20
White light	48VDC
Min cut (mm)	166.6
Max.power (W/m)	5.8
Typ.power (W/m)	5.4
Lumens (LM/m)	130/130/140/140/150
CCT / Color	
CRI	>80/90
Min bending radius (mm)	>60
IP	IP67

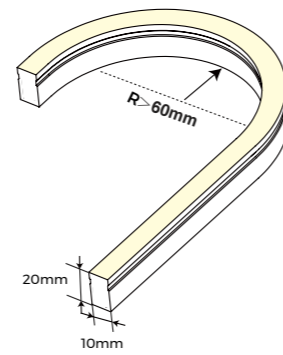

Series	Flat luminous surface series (Top bend)
Model	NMT1312-Plus
Size (mm)	White light/R/G/B/Y : 5000/10000×13×12 RGB/RGBX/RGBW/SWW: 5000×13×12
White light	24VDC
Min cut (mm)	White light: 50/RGB 83 RGBX: 71.43 RGBW:62.5 SWW:31.25
Max.power (W/m)	10.6 (White light) ; 8.8(RGBY) ; 13.2 (RGB) ; 20.2 (RGBX) ; 16.5 (RGBW) ; 14(SWW)
Typ.power (W/m)	9.6 (White light) ; 8(RGBY); 12 (RGB) ; 18 (RGBX) ; 14.4 (RGBW) ; 12 (SWW)
Lumens (LM/m)	640/640/670/670
CCT / Color	
CRI	>80/90
Min bending radius (mm)	>60
IP	IP67

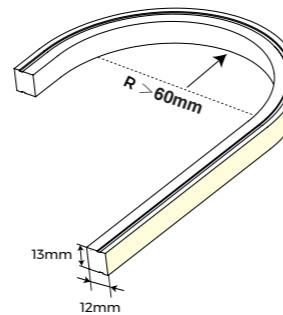

Series	Flat luminous surface series (Top bend) NEW
Model	NMT1312U (3 sides luminous surface)
Size (mm)	White light : 5000/10000×13×12
White light	24VDC
Min cut (mm)	41.66
Max.power (W/m)	12
Typ.power (W/m)	11
Lumens (LM/m)	750/750/800/800
CCT / Color	
CRI	>80/90
Min bending radius (mm)	>60
IP	IP67

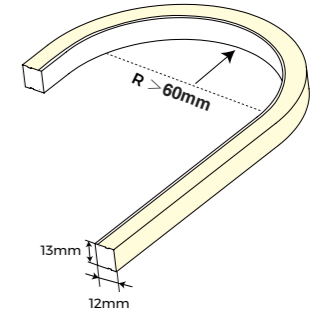

Series	Flat luminous surface series (Side bend)
Model	NMS1217-Plus
Size (mm)	White light/R/G/B/Y : 5000/10000×12×17 RGB/RGBX/RGBW/SWW: 5000×12×17
White light	24VDC
Min cut (mm)	White light: 50/RGB 83 RGBX: 71.43 RGBW:62.5 SWW:100
Max.power (W/m)	10.6 (White light) ; 8.8(RGBY) ; 13.2 (RGB) ; 20.2 (RGBX) ; 16.5 (RGBW) ; 14(SWW)
Typ.power (W/m)	9.6 (White light) ; 8(RGBY); 12 (RGB) ; 18 (RGBX) ; 14.4 (RGBW) ; 12 (SWW)
Lumens (LM/m)	510/520/520/520
CCT / Color	
CRI	>80/90
Min bending radius (mm)	>60
IP	IP67

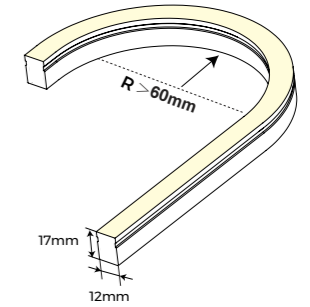

Series	Flat luminous surface series (Top bend)
Model	NMT1515
Size (mm)	White light/R/G/B/Y : 5000/10000×15×15 RGB: 5000×15×15
White light	24VDC
Min cut (mm)	White light50/RGB 83
Max.power (W/m)	10.6 (White light) ; 8.8(RGBY) ; 13.2 (RGB)
Typ.power (W/m)	9.6 (White light) ; 8(RGBY); 12 (RGB)
Lumens (LM/m)	520/580/590/580
CCT / Color	
CRI	>80/90
Min bending radius (mm)	>60
IP	IP67

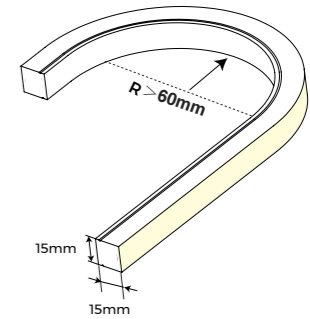

Series	Flat luminous surface series (Side bend)
Model	NTS1220
Size (mm)	5000x12x20
White light	5/12/24VDC
Min cut (mm)	16.6/50/83/100
Max.power (W/m)	10.6 (White light) ; 8.8(RGBY); 13.2(RGB) ;14.4(RGBX);14(SWW)
Typ.power (W/m)	9.6 (White light) ; 8(RGBY); 12(RGB);13(RGBX); 12(SWW)
Lumens (LM/m)	220/220/230/190
CCT / Color	
CRI	>80/90
Min bending radius (mm)	>60
IP	IP65

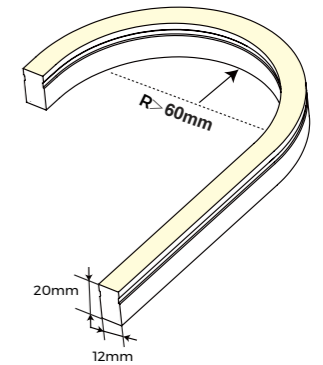

Product List

Series	Flat luminous surface series (3D) NEW
Model	NM3D1515
Size (mm)	5000×15×15
White light	24VDC
Min cut (mm)	41.66
Max.power (W/m)	8
Typ.power (W/m)	7.2
Lumens (LM/m)	450/510/510/500
CCT / Color	2300K 2800K 3200K 4400K R G B Y
CRI	>80/90
Min bending radius (mm)	>60
IP	IP67

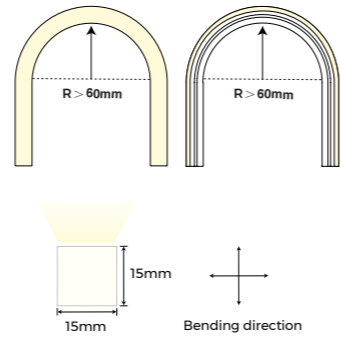

Series	Curve luminous surface series(Top bend)
Model	NNT1615
Size (mm)	White light : 15000×16×15 RGB: 5000×16×15
White light	24VDC
Min cut (mm)	41.66/50
Max.power (W/m)	12(White light) ; 14.4 (RGB)
Typ.power (W/m)	11(White light) ; 12 (RGB)
Lumens (LM/m)	750/780/800/820/800
CCT / Color	2300K 2700K 3000K 3700K 5000K RGB
CRI	>80/90
Min bending radius (mm)	>60
IP	IP67

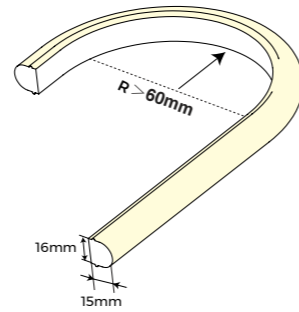

Series	Curve luminous surface series(Side bend) NEW
Model	NNS1224
Size (mm)	White light/R/G/B/Y/: 5000/10000×12×24 RGB: 5000×12×24
White light	24VDC
Min cut (mm)	White light 50/RGB 83
Max.power (W/m)	10.6 (White light) ; 8.8(RGBY) ; 13.2 (RGB) ;
Typ.power (W/m)	9.6 (White light) ; 8(RGBY); 12 (RGB) ;
Lumens (LM/m)	510/520/520/520/490
CCT / Color	2300K 2700K 3200K 4200K 5000K R G B Y RGB
CRI	>80/90
Min bending radius (mm)	>60
IP	IP68

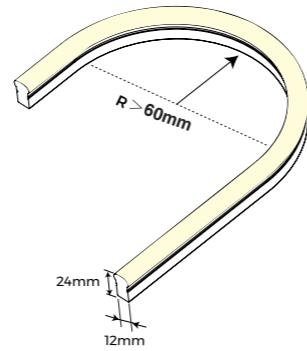

Series	Curve luminous surface series NEW
Model	NNR25
Size (mm)	5000×φ25
White light	24VDC
Min cut (mm)	41.66
Max.power (W/m)	16
Typ.power (W/m)	14.4
Lumens (LM/m)	900/950/950/900
CCT / Color	2300K 2700K 3000K 4000K
CRI	>80/90
Min bending radius (mm)	>60
IP	IP65

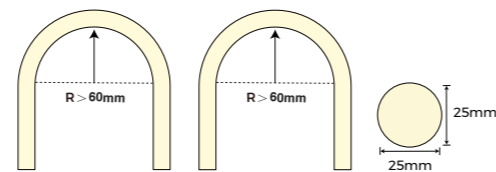

Ordering Code

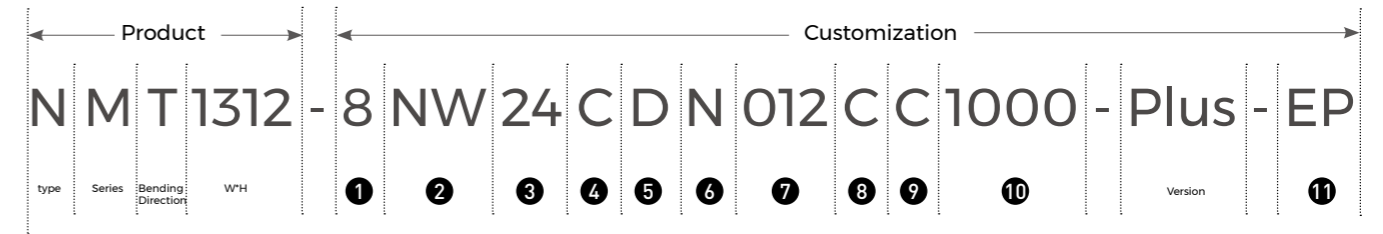

Simple steps, open to the outside world in an all-round way, customize personalized product

CRI	Code 1
RGB or colorful, no CRI	0
CRI<80	7
CRI>80	8
CRI>90	9

Silk Printing	Code 4
Standard	C
Neutral	N
Customized	S

Package for distributors	Code 8
Standard	C
Package for distributors	B

CCT/color	Code 2
2200-2400K	LW
2600-2800K	SW
2800-3200K	VW
3200-3800K	PW
3800-4200K	NW
4800-5200K	DW
Red	R
Green	G
Blue	B
Yellow	Y
Adjustable CCT	SWW
RGB	RGB
RGBW	RGBW
RGBX	RGBX

Entry cable	Code 5
One end	S
Dual-ends	D
No	X

Label Type	Code 9
Standard	C
Customized	S

Wire Type	Code 6
PVC	N
No wire	X
Silicone wire	S

Strip Length	Code 10
50m/reel	5000
15m/reel	1500
10m/reel	1000
5m/reel	0500

Wire Length	Code 7
50CM	050
No wire	000

IP	Code 11
IP68	EP
IP67	NP

Operating voltage	Code 3
DC5V	05
DC12V	12
DC24V	24
DC48V	48

360° round luminous surface NEW

NNR25

- 360° uniform round-glowing design, applicable to space decoration lighting.
- IP65, suitable for rainy environment.
- Pendant and surface mounted are achievable.

2300 K 2700 K 3000 K 4000 K



Twist or bend in 3 dimensions NEW

NM3D1515

- IP67 outstanding weather resistance
- Multiple accessories for various applications

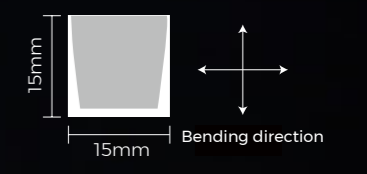

Creative design for various applications of top bend and side bend in 3D space

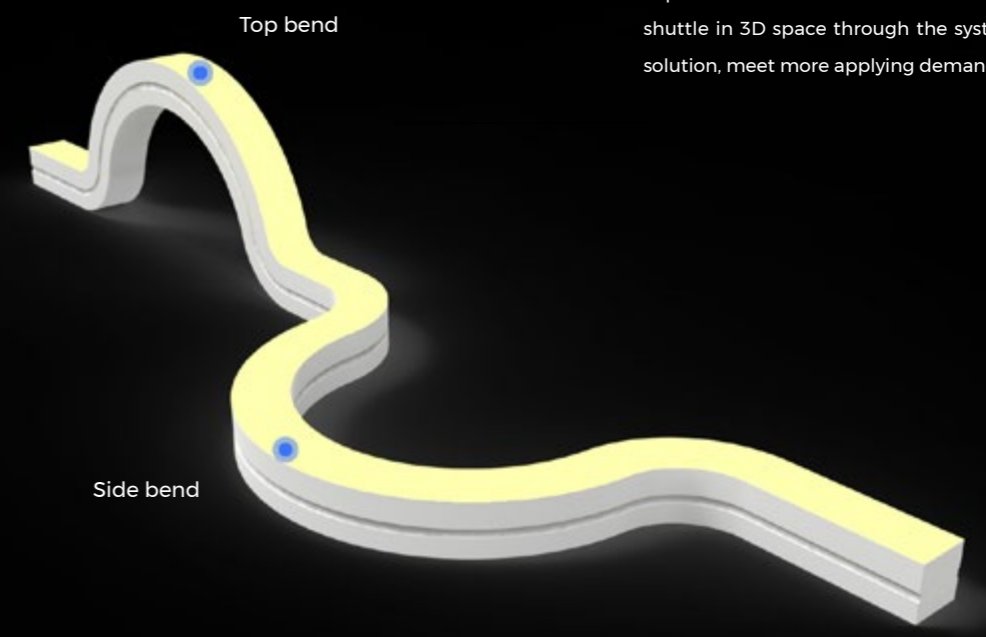

Top bend and side bend combined into one, directly shuttle in 3D space through the systematic installation solution, meet more applying demands.

IP68, 270° large luminous surface NEW

NNS1224

- 270° dome structure design, large luminous surface and homogeneous light
- IK08, IP68, able to be used in soaking environment
- Systematized solution of installation.

2300 K 2700 K 3200 K 4200 K 5000 K R G B Y RGB

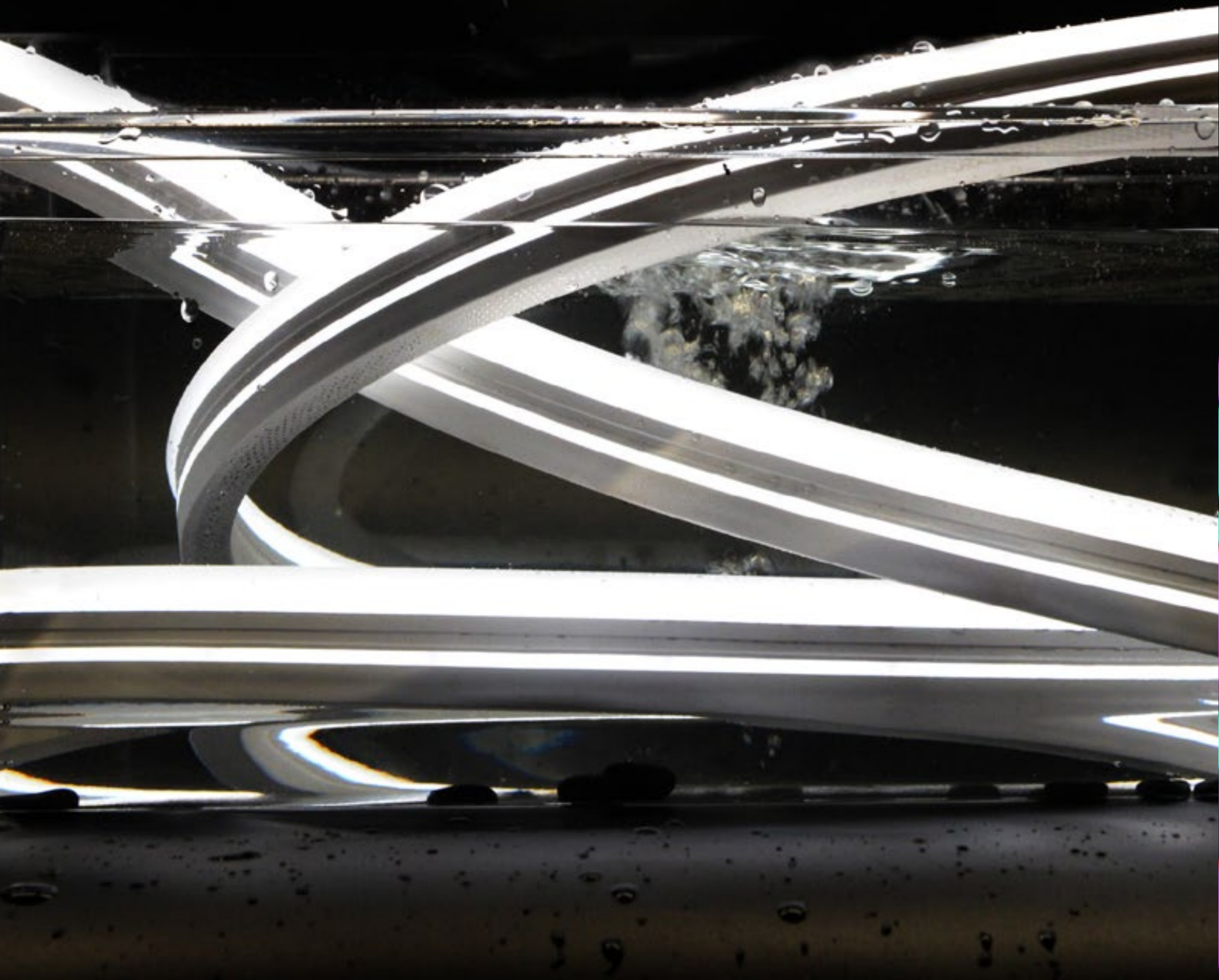
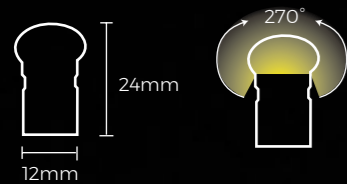

Dimming and toning change as you like NEW

NTS1220 / NMT1312-Plus / NMS1217-Plus

- Colorful and changes magically, pure color
- IP65/IP67 suitable for rainy environment or short-term soaking environment

2300 K 2700 K 3000 K 4000 K R G B Y RGB CCT R G B W Pixel



Silicone Neon Strip Solution

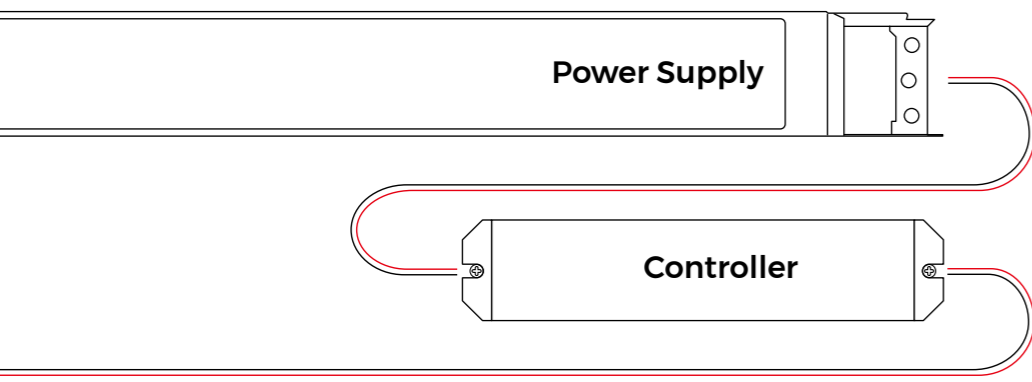

Cutting line

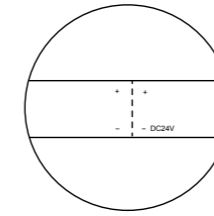

Connector

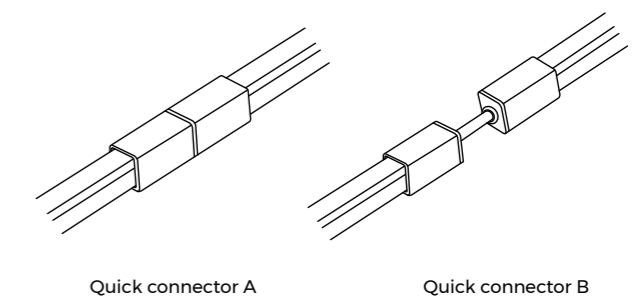

End cap

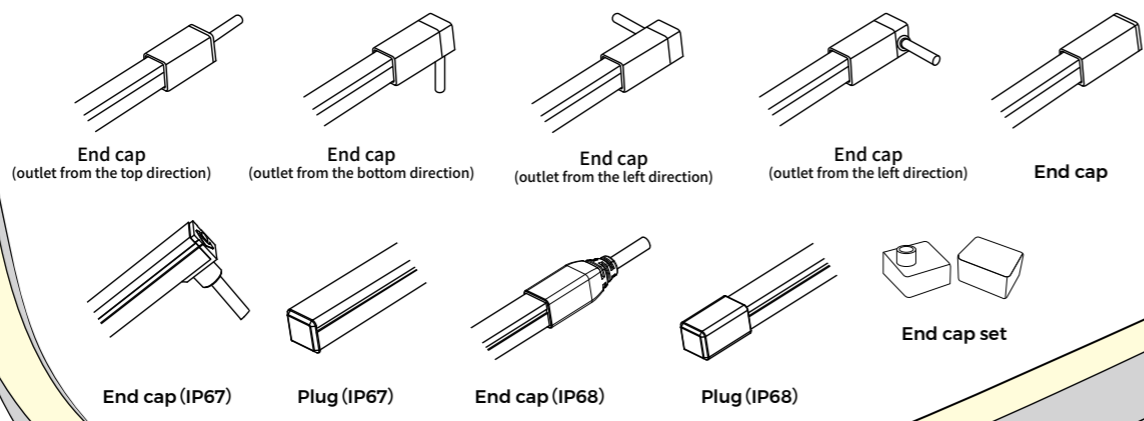

Installation Accessories

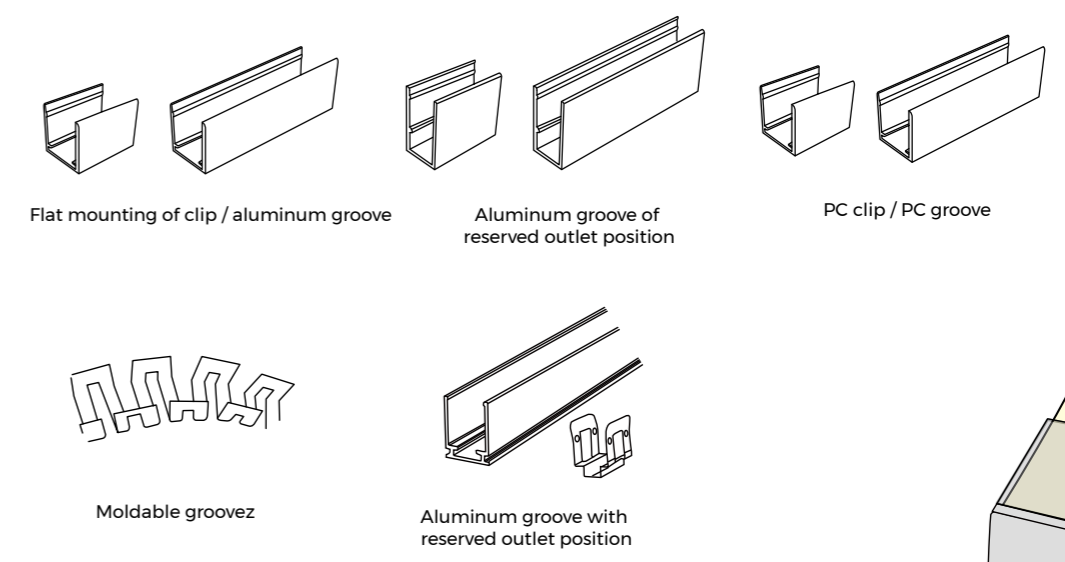

LED

Ra/CRI > 80/90



ONE BIN SDCM<2

Package

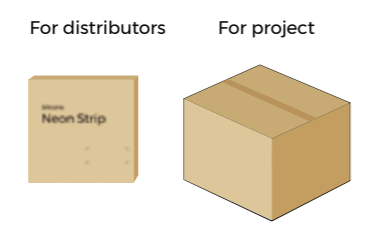

Wire & Glue

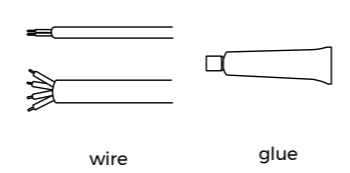

IP Process Technology

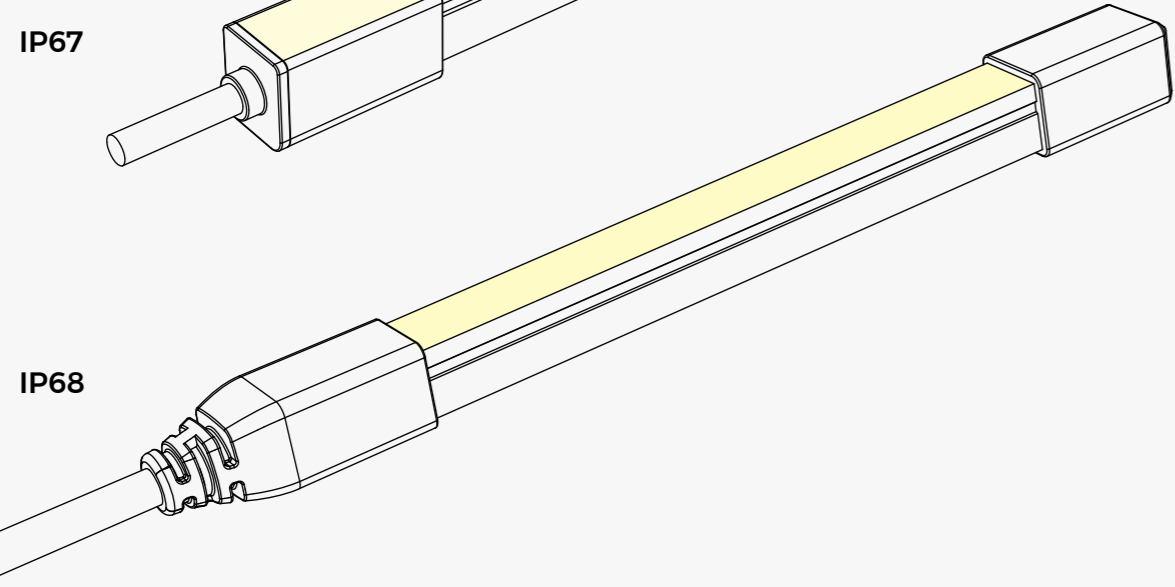
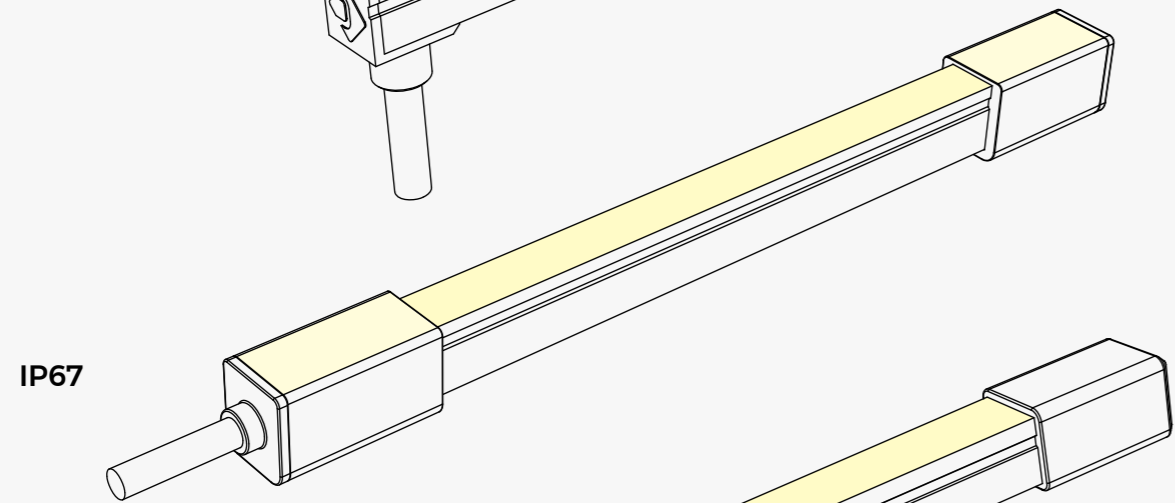
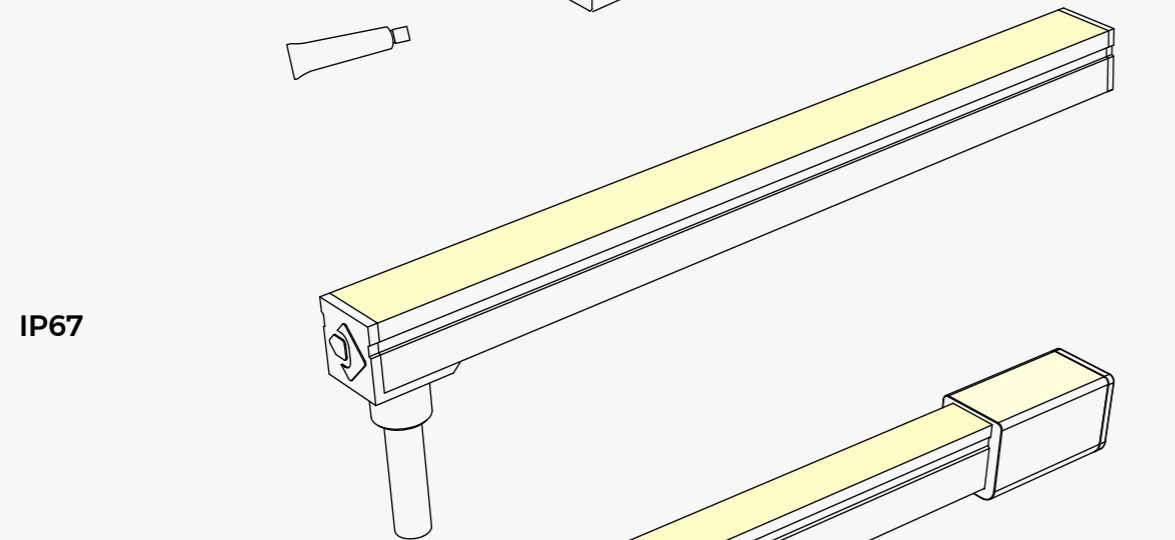
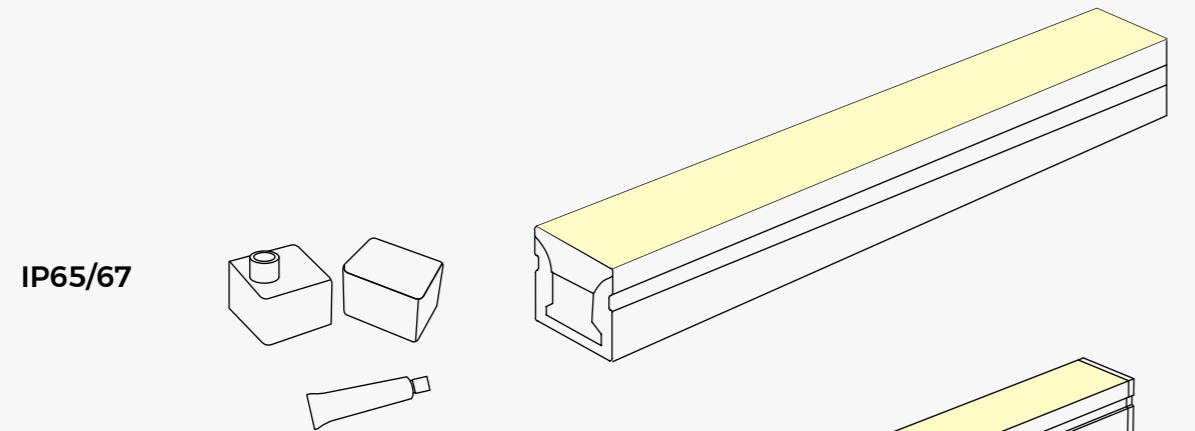

IP67 end cap without dark area

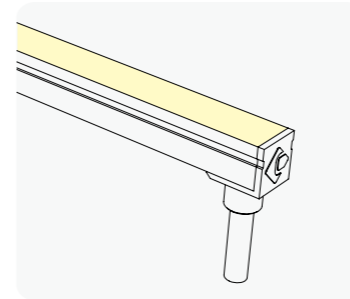

Linear interconnection without dark area

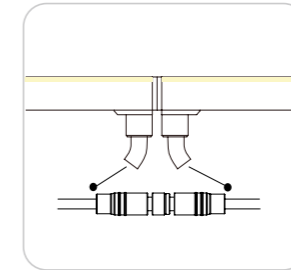

Curve interconnection of lighting outward without dark area

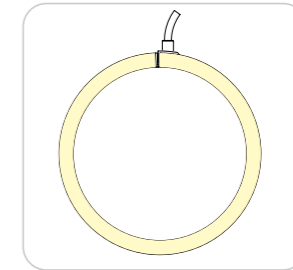

Curve interconnection of lighting inward without dark area

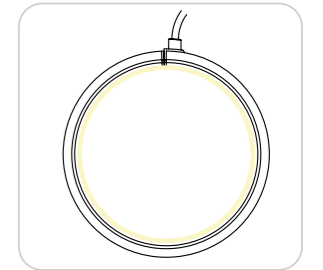

IP67 soldering-free quick connector

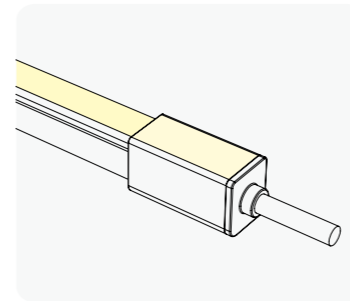

Quick connector (Without wire)

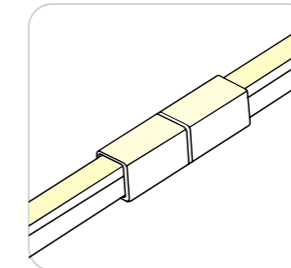

Quick connector (With wire)

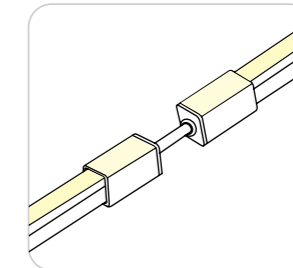

Deconstruction diagram of soldering free interconnted accessory

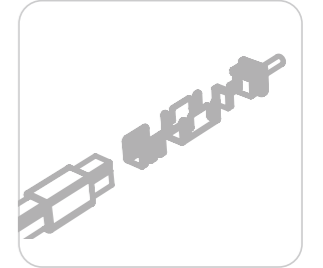

IP68 end cap, can be used in the bottom of swimming pool

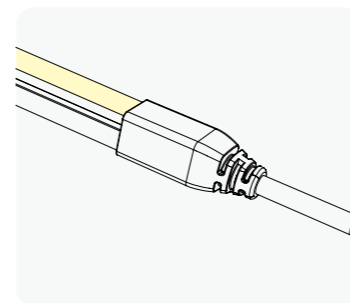

Pool



Performance Feature



High substitutability

Featuring high substitutability, can achieve various lighting effects such as white light, RGB and digital toning, it can replace the neon tube, guardrail tube, rainbow tube and so on for signage lighting/architectural lighting/landscape lighting.



High thermal conductivity

High thermal conductivity, the thermal conductivity of silicone is 0.27W/MK, better than the "0.14W/MK" of PVC, and the strip features longer effective heat dissipation life.

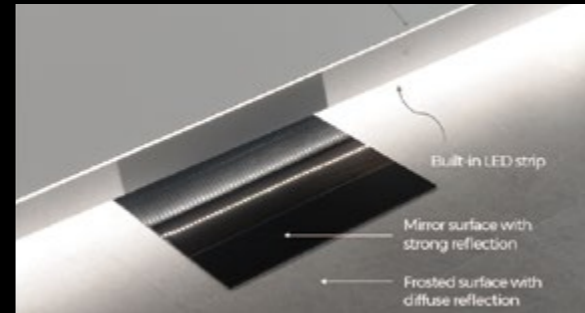

Uniform Lighting

Uniform Lighting, dot-free, direct-view surface, used for highly reflective material, featuring a glossy environment free from dazzling.

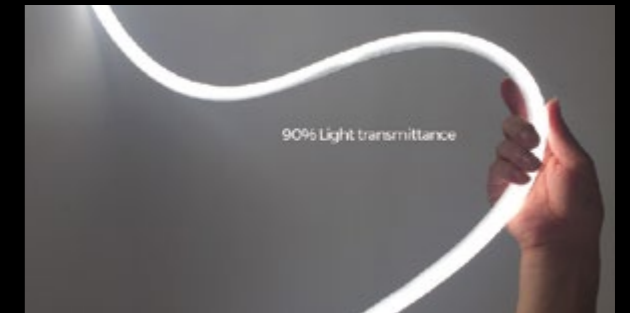

High light transmittance

High light transmittance up to 90%, can meet the requirements of high lumens output, and it's not only used for decoration but also lighting.



Resistance to UV

Featuring resistance to UV, the extrusion silicone can be used outdoor environment for long-term exposure to direct sunlight, no yellowing and aging over 5 years.



Flame-retardant and environmental

It is environmental and non-toxic, with high ignition point, non-flammable in needle-flame burning, and without irritating toxic gases volatilizing (not like PVC), which is more secure.



Good flexibility

Reliable structure with good flexibility, adopting solid silicone, customizing internal structure and external form by mould. It can be bent and twisted, suitable for various shapes, with resistance to tear and draw, it is not easy to damage and deform with good flexibility



Outstanding weather resistance

Outstanding weather resistance, storing in the environment between -50°C and +150°C, it can maintain the normal-soft state, without embrittlement, deformation, softening and aging. And using in the environment between -20°C and +45°C, it can operate normally resisting extremely cold and high heat.



Resistance to corrosive gases

Resistance to corrosive gases, include chlorine, sulfur dioxide, hydrogen sulfide, nitrogen dioxide and so on, the silicone neon strip with long life span can be used for severe environment



Dust proof

Avoid dust into the neon strip, and featuring reliable sealing, up to IP6X, beautiful appearance, wide range of applications and long life span.



Resistance to corrosion

Featuring resistance to corrosion, the silicone can resist corrosion of normal salt, alkali and acid, can be used for special environments such as beach, yacht, chemical industry, petroleum, mine and laboratory.

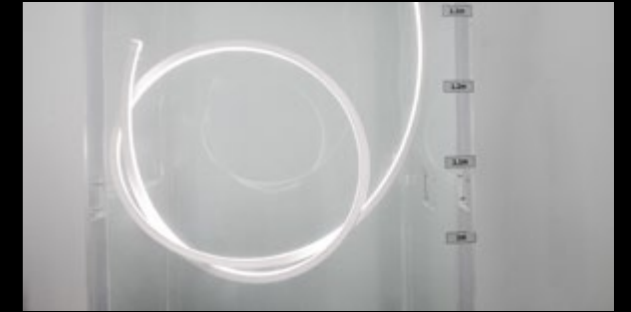

Good protective performance

Good protective performance, the main body of product and standard outlet end cap can be used in the environment up to IP67 standard, and can pass the laboratory test standards of IP68

Installation Solution

Provide multiple installation accessories for top bend and side bend, meet various applying demands.

End cap

Outlet from the horizontal (top) direction



Outlet from the bottom direction



Outlet from the left direction



Outlet from the right direction



Mounting clip

Aluminum clip (outlet)

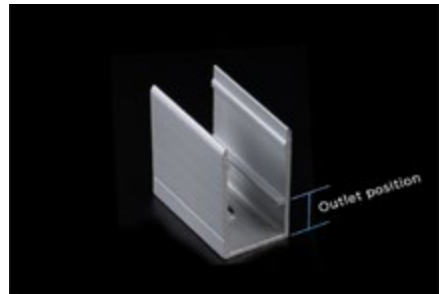

Aluminum clip

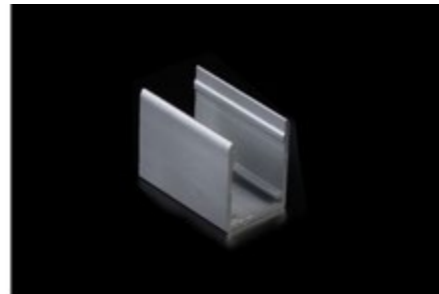

PC clip



Mounting groove

Aluminum groove

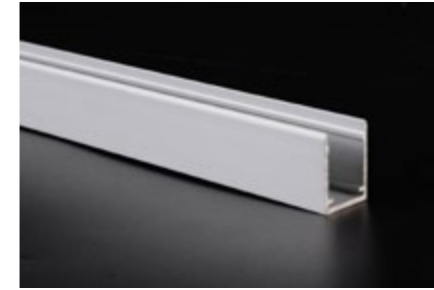

Aluminum groove (outlet)

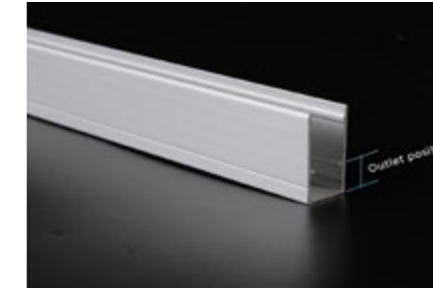

PC groove

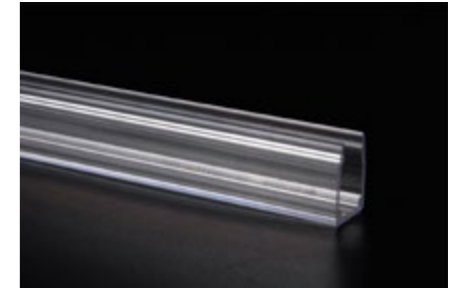

Aluminum groove with reserved outlet position



Moldable mounting groove NMS1217 (Side bend)



Moldable mounting groove NMT1312 (Top bend)

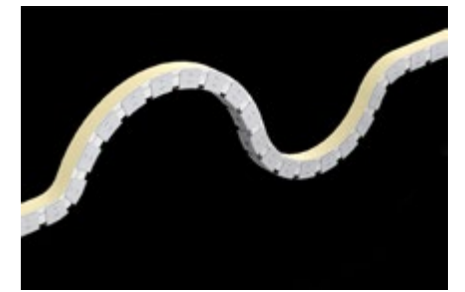
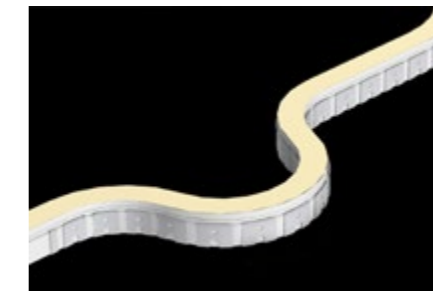
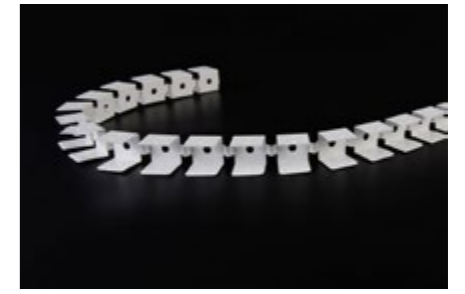

NTS0410(Side bend)

- Ultra-thin 4mm luminous surface, applicable to signage & indoor decoration lighting
- High luminous efficiency, LM80 proved
- Silicone extrusion molding technology, IK06, IP65
- 3 years warranty, life span over 36000 hours

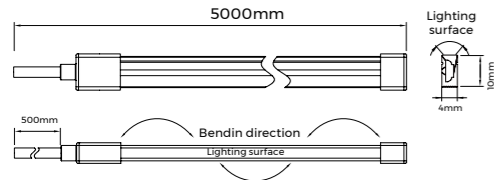

24V/12V DC 5m REEL

Basic Parameters	
Size	5000×04×10mm
Cutting unit	41.66mm/17.86mm
Input voltage	12/24VDC
Input current	0.6A/1m (12V) 0.3A/1m (24V)
Typ.power	7.2W/m
Max.power	8W/m
Bend radius	>30mm

Photo-electric Parameters			
CRI	CCT	LM/m	LM/W
>80/90	2300 K	240	33
	2700 K	290	40
	3000 K	300	42
	4000 K	300	42
	R 620-630nm		
	G 525-530nm		
	B 465-470nm		
	Y 587-592nm		

1. The above parameters are tested based on 1M standard products;
2. The power and luminous flux are allowed to have an error range of ±10%;
3. The above parameters are typical values;

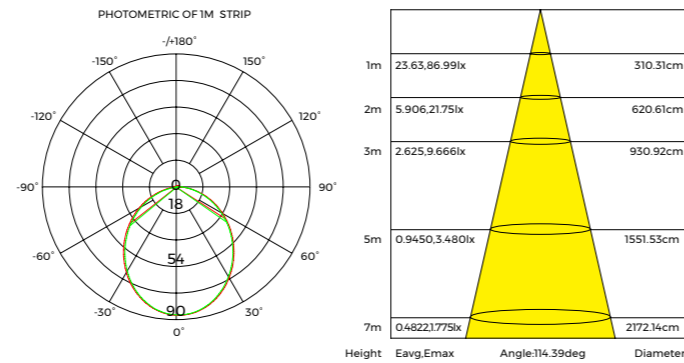

Ordering Code

Category	Series	Bending direction	Section Size	CRI	CCT	Voltage	Silk Printing	Entry Cable	Wire Type	Wire Length	Brand Code	Label Type	LED Strip Length													
Silicone neon strip	N	T	S	0410	8	24	C	S	N	050	C	C	0500													
														Standard	Dual ends	D	PVC	N	500mm	050	Standard	C	Standard	C		
														Customized	One end	S	Silica	S			Package for distributors	B	Customized	S		
														Neutral screen	No	X										

NTS0410-8LW24CSN050CC0500

NMS0612(Side bend)

- 6mm luminous surface, applicable to signage & indoor and outdoor decoration lighting
- High luminous efficiency, LM80 proved
- Silicone extrusion molding technology, IK06, IP67
- 3 years warranty, life span over 36000 hours

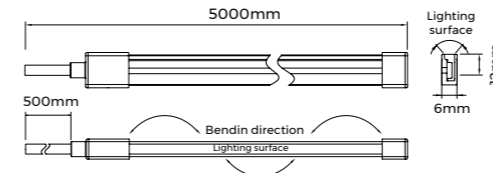

12V DC 24V DC 5m REEL

Basic Parameters	
Size	5000×06×12mm
Cutting unit	25mm / 50mm
Input voltage	12VDC/24VDC
Input current	0.8A/1m ; 0.67A/1m (RGBY) @ 12VDC 0.4A/1m ; 0.34A/1m (RGBY) @ 24VDC
Typ.power	9.6W/m (White Light) 8W/m (RGBY)
Max.power	10.6W/m (White Light) 8.8W/m (RGBY)
Bend radius	>30mm

Photo-electric Parameters			
CRI	CCT	LM/m	LM/W
>80/90	2300 K	230	24
	2700 K	240	25
	3000 K	240	25
	4000 K	220	23
	4500 K	240	25
	R 620-630nm		
	G 525-530nm		
	B 465-470nm		
	Y 587-592nm		

1. The above parameters are tested based on 1M standard products;
2. The power and luminous flux are allowed to have an error range of ±10%;
3. The above parameters are typical values;

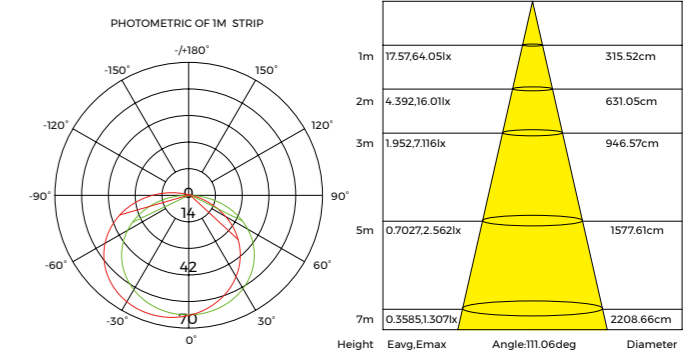

Ordering Code

Category	Series	Bending direction	Section Size	CRI	CCT	Voltage	Silk Printing	Entry Cable	Wire Type	Wire Length	Brand Code	Label Type	LED Strip Length	Version	IP													
Silicone neon strip	N	M	S	0612	8	24	C	S	N	050	C	C	0500	Plus	EP													
																Standard	Dual ends	D	PVC	N	500mm	050	Standard	C	Standard	C		
																Customized	One end	S	Silica	S			Package for distributors	B	Customized	S		
																Neutral screen	No	X										

NMS0612-8LW24CSN050CC0500

NMT1515(Top bend)

- 15mm luminous surface, applicable to indoor and outdoor decoration lighting, building structure decoration lighting
- High luminous efficiency, LM80 proved
- Silicone extrusion molding technology, IK08, IP67
- 3 years warranty, life span over 36000 hours

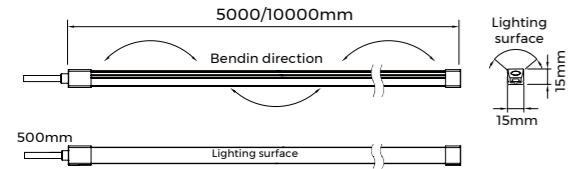

24V DC 5/10m REEL

Basic Parameters	
Size	White Light: 5000×15×15 & 10000×15×15 R, G, B, Y, RGB: 5000×15×15
Cutting unit	Single Color 50mm & RGB 83mm
Input voltage	24VDC
Input current	0.4A/1m 0.34A/1m (R/G/B/Y) 0.5A/1m (RGB)
Typ.power	9.6W/m (White Light) 8W/m(RGBY) 12W/m (RGB)
Max.power	10.6W/m (White Light) 8.8W/m(RGBY) 13.2W/m (RGB)
Bend radius	>60mm

Recommended Accessories	
Moldable groove	L : 5000mm, With screws
Mounting clip	L : 95mm, With screws
End cap set	One end cap+one plug
Gum filler	10ml/pcs
Wire	L : 0.5m 2P : 2X0.5mm ² L : 2m 2P : 2X0.5mm ²
Wire	L : 0.5m 4P : 4X0.5mm ² L : 2m 4P : 4X0.5mm ²

Photo-electric Parameters			
CRI	CCT	LM/m	LM/W
>80/90	2300K	520	54
	2700K	580	60
	3000K	590	61
	4000K	580	60
	R 620-630nm	/	/
	G 525-530nm	/	/
	B 465-470nm	/	/
	Y 587-592nm	/	/
	RGB	/	/

1. The above parameters are tested based on 1M standard products;
2. The power and luminous flux are allowed to have an error range of ±10%;
3. The above parameters are typical values;

Ordering Code

Category	Series	Bending direction	Section Size	CRI	CCT	Voltage	Silk Printing	Entry Cable	Wire Type	Wire Length	Brand Code	Label Type	LED Strip Length
Silicone neon strip	N Moonlight Series	M Top bend	T 15X15mm 1515	Ra>80 8	2300K LW	24V 24	Standard	C Dual-ends	D PVC N	500mm 050	Standard	C Standard	C 5M 0500
				Ra>90 9	2700K SW		Customized	S Oneend	S Silica S		Package for distributors	B Customized	S 10M 1000
					3000K WW		Neutral screen	N No	X				
					4000K NW								
					R Red								
					G Green								
					B Blue								
					Y Yellow								
					RGB Colorful								
	N	M	T	1515	-	8							0500

NMT1515-8LW24CSN050CC0500

NTS1220(Side bend)

- 12mm luminous surface, applicable to signage, indoor and outdoor decoration lighting
- High luminous efficiency, LM80 proved
- Silicone extrusion molding technology, IK08, IP65
- 3 years warranty, life span over 36000 hours(RGB digital 2 years)

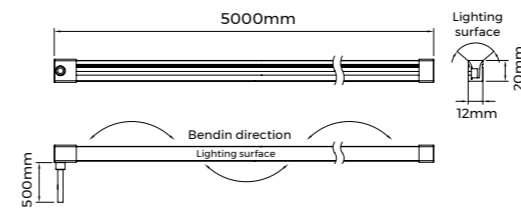

5V DC 12V DC 24V DC 5m REEL

Basic Parameters							
Series	Cutting unit	Input voltage	Input current	Typ. power	Max. power	Size	Bend radius
Single Color	50mm	24V	0.4A	9.6W/m	10.6W/m	5000×12×20mm	>60mm
RGBY	50mm	24V	0.34A	8W/m	8.8W/m	5000×12×20mm	
RGB	83mm	24V	0.5A	12W/m	13.2W/m	5000×12×20mm	
RGBX-5V	16.6mm	5V	2.4A	13W/m	14.4W/m	5000×12×20mm	
RGBX-12V	50mm	12V	1A	13W/m	14.4W/m	5000×12×20mm	
SWW	100mm	24V	0.5A	12W/m	14W/m	5000×12×20mm	

Recommended Accessories	
Flat mounting aluminum groove	L : 1000mm, With screws
Flat mounting clip	L : 25mm, With screws
End cap set	One end cap+one plug
Gum filler	10ml/pcs
Wire	L : 0.5m 2P : 2X0.5mm ² L : 2m 2P : 2X0.5mm ²
Wire	L : 0.5m 4P : 4X0.5mm ² L : 2m 4P : 4X0.5mm ²

Photo-electric Parameters			
CRI	CCT	LM/m	LM/W
>80/90	2300K	220	23
	2700K	220	23
	3000K	230	23
	4000K	190	20
	2300-4000K	330	23
	R 620-630nm	/	/
	G 525-530nm	/	/
	B 465-470nm	/	/
	Y 587-592nm	/	/
	RGB	/	/
	RGBX	/	/

1. The above parameters are tested based on 1M standard products;
2. The power and luminous flux are allowed to have an error range of ±10%;
3. The above parameters are typical values;

Ordering Code

Category	Series	Bending direction	Section Size	CRI	CCT	Voltage	Silk Printing	Entry Cable	Wire Type	Wire Length	Brand Code	Label Type	LED Strip Length
Silicone neon strip	N Dual-color Fog Casing	T Side View	S 12X20mm 1220	Ra>80 8	2300K LW	24V 24	Standard	C Dual-ends	D PVC N	500mm 050	Standard	C Standard	C 5M 0500
				Ra>90 9	2700K SW	5V 5	Customized	S Oneend	S Silica S	2000mm 200	Package for distributors	B Customized	S
					3000K WW	12V 12	Neutral screen	N No	X				
					4000K NW								
					R Red								
					G Green								
					B Blue								
					Y Yellow								
					RGB Colorful								
					RGBX Colorful								
	N	T	S	1220	-	8							0500

NTS1220-8LW24CSN050CC0500

NMS1020(Side bend)

- 10mm luminous surface, applicable to signage, indoor and outdoor decoration lighting ,building structure decoration lighting.
- High luminous efficiency, LM80 proved.
- DC48V, 50m ultra-long application.
- Silicone extrusion molding technology, IK08, IP67.
- 3 years warranty, life span over 36000 hours.

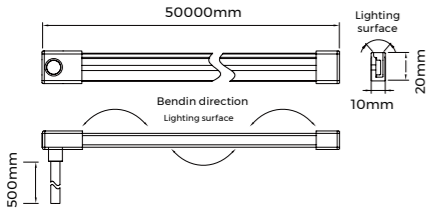

48V DC 50m REEL

Basic Parameters

Size	50000×10×20mm
Cutting unit	166mm
Input voltage	48VDC
Input current	0.12A/1m
Typ.power	5.4W/m
Max.power	5.8W/m
Bend radius	>60mm

Recommended Accessories

Aluminum clip	L: 25mm, with screws	
Flat mounting aluminum groove	L: 1000mm, With screws	
End cap set	One end cap+one plug	
Gum filler	10ml/pcs	
Wire	L: 0.5m 2P: 2X0.75mm² L: 2m 2P: 2X0.75mm²	

Photo-electric Parameters

CRI	CCT	LM/m	LM/W
>80/90	2300 K	130	22
	2700 K	130	22
	3000 K	140	24
	4300 K	140	24
	5000 K	150	26

1. The above parameters are tested based on 1M standard products;
2. The power and luminous flux are allowed to have an error range of ±10%;
3. The above parameters are typical values;

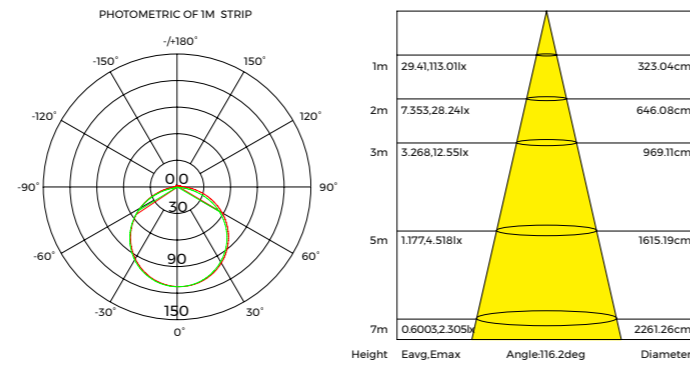

Ordering Code

Category	Series	Bending direction	Section Size	CRI	CCT	Voltage	Silk Printing	Entry Cable	Wire Type	Wire Length	Brand Code	Label Type	LED Strip Length																														
Silicone neon strip	N	M	Side View S	10X20mm	1020	48V	48	Standard	C	Dual-ends	D	PVC	N	500mm	050	Standard	C	Standard	C	50M	5000																						
																						Ra>80	8	2300K	LW	24	24	Standard	C	Dual-ends	D	PVC	N	500mm	050	Standard	C	Standard	C	50M	5000		
																						Ra>90	9	2700K	SW	Standard	S	One-end	S	Silica	S	Package for distributors	B	Customized	S								
																								3000K	WW	Neutral screen	N	No	X														
																								4300K	NW																		
																								5000K	DW																		
N	M	S	1020	8	SW	48	C	S	N	050	C	C	5000																														

NMS1020-8SW48CSN050CC5000

NM3D1515(3D) NEW

- 15mm luminous surface, twist and bend in 3D, applicable to signage, indoor and outdoor decoration lighting, building structure decoration lighting.
- High luminous efficiency, LM80 proved.
- Silicone extrusion molding technology, IK08,IP67
- 3 years warranty, life span over 36000 hours.

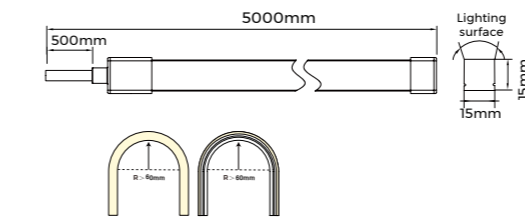

24V DC 5m REEL

Basic Parameters

Size	5000×15×15mm
Cutting unit	41.66mm
Input voltage	24VDC
Input current	0.3A/m
Typ.power	7.2W/m
Max.power	8W/m
Bend radius	>60mm

Recommended Accessories

Flat mounting aluminum groove	L: 1000mm	
Moldable groove	L: 500mm, With screws	
End cap set	One end cap+one plug	
Gum filler	10ml/pcs	
Wire	L: 0.5m 2P: 2X0.5mm² L: 2m 2P: 2X0.5mm²	

Photo-electric Parameters

CRI	CCT	LM/m	LM/W
>80/90	2300 K	450	62
	2800 K	510	70
	3200 K	510	70
	4400 K	500	69
	R 620-630nm		
	G 525-530nm		
	B 465-470nm		
	Y 587-592nm		

1. The above parameters are tested based on 1M standard products;
2. The power and luminous flux are allowed to have an error range of ±10%;
3. The above parameters are typical values;

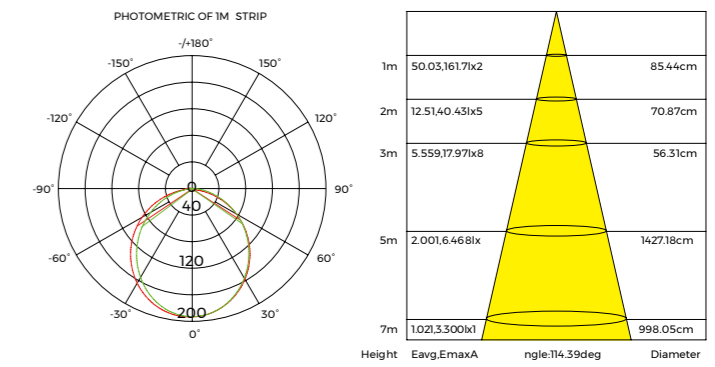

Ordering Code

Category	Series	Bending direction	Section Size	CRI	CCT	Voltage	Silk Printing	Entry Cable	Wire Type	Wire Length	Brand Code	Label Type	LED Strip Length																														
Silicone neon strip	N	M	3D	15X15mm	1515	48V	48	Standard	C	Dual-ends	D	PVC	N	500mm	050	Standard	C	Standard	C	50M	5000																						
																						Ra>80	8	2300K	LW	24	24	Standard	C	Dual-ends	D	PVC	N	500mm	050	Standard	C	Standard	C	50M	5000		
																						Ra>90	9	2700K	SW	Standard	S	One-end	S	Silica	S	Package for distributors	B	Customized	S								
																								3000K	WW	Neutral screen	N	No	X														
																								4000K	NW																		
																								R	Red																		
																								G	Green																		
																								B	Blue																		
																								Y	Yellow																		
N	M	3D	1515	8	LW	24	C	S	N	050	C	C	5000																														

NM3D1515-8LW24CSN050CC5000

NNT1615(Top bend)

- Dome structure design, gentle and homogeneous light, applicable to signage, indoor and outdoor decoration lighting, building structure decoration lighting.
- High luminous efficiency, LM80 proved.
- Silicone extrusion molding technology, IK08, IP67
- DC24V, wide voltage tolerance design
- 15m ultra-long application, same brightness from one end to another.
- 3 years warranty, life span over 36000 hours.

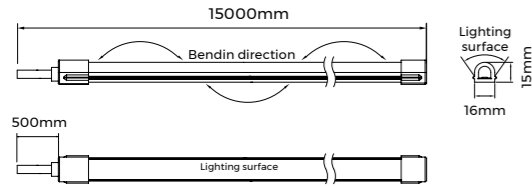

24V DC 5m REEL 15m REEL

Basic Parameters

Size	15000×16×15mm
	5000×16×15mm
Cutting unit	41.66mm/50mm
Input voltage	24VDC
Input current	0.46A/1m
	0.6A/1m (RGB)
Typ.power	11W/m & 12W/m(RGB)
Max.power	12W/m & 14.4W/m(RGB)
Bend radius	>60mm

Photo-electric Parameters

CRI	CCT	LM/m	LM/W
>80/90	2300 K	750	68
	2700 K	780	70
	3000 K	800	72
	3700 K	820	74
	5000 K	800	72
	RGB	/	/

1. The above parameters are tested based on 1M standard products;
2. The power and luminous flux are allowed to have an error range of ±10%;
3. The above parameters are typical values;

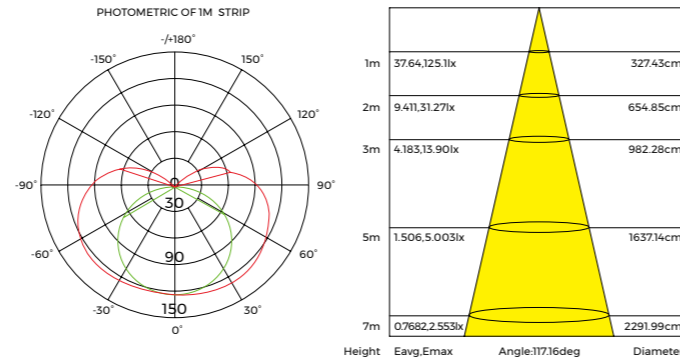

Ordering Code

Category	Series	Bending direction	Section Size	CRI	CCT	Voltage	Silk Printing	Entry Cable	Wire Type	Wire Length	Brand Code	Label Type	LED Strip Length	Version	IP																													
Silicone neon strip	N	Domed Neon	T	16X15mm	1615	24V	Standard	C	Dual-ends	D	PVC	N	500mm	050	Standard	C	Standard	C	15M	1500	Plus	EP																						
																							Ra>80	8	2300K	LW	24	24	Standard	C	Dual-ends	D	PVC	N	500mm	050	Standard	C	Standard	C	15M	1500	Plus	EP
																							Ra>90	9	2700K	SW			Customized	S	Oneend	S	Silica	S			Package for distributors	B	Customized	S			NP	
																									3000K	WW			Neutral screen	N	No	X												
																									3700K	NW																		
																									5000K	DW																		
																									0	0	RGB																	

NNT1615-8LW24CSN050CC1500

NNS1224(Side bend) NEW

- 270° dome structure design, large luminous surface and homogeneous light, applicable to signage, indoor and outdoor decoration lighting, building structure decoration lighting, swimming pool.
- High luminous efficiency, LM80 proved.
- Silicone extrusion molding technology, IK08, IP68.
- Systematized solution of installation.
- 3 years warranty, life span over 36000 hours.

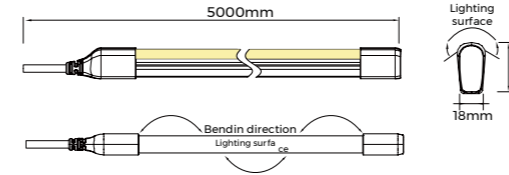

24V DC 5/10m REEL

Basic Parameters

Size	5000/10000×16×15mm
Cutting unit	50mm & RGB 83mm
Input voltage	24VDC
Input current	0.4A/m & 0.34A/m (R/G/B/Y)
	0.5A/m (RGB)
Typ.power	9.6W/m & 8W/m (R/G/B/Y)
	12W/m (RGB)
Max.power	10.6W/m & 8.8W/m (R/G/B/Y)
	13.2W/m(RGB)
Bend radius	>60mm

Photo-electric Parameters

CRI	CCT	LM/m	LM/W
>80/90	2300 K	510	53
	2700 K	520	54
	3200 K	520	54
	4200 K	520	54
	5000 K	490	51
	R	/	/
	G	/	/
	B	/	/
	Y	/	/
	RGB	/	/

1. The above parameters are tested based on 1M standard products;
2. The power and luminous flux are allowed to have an error range of ±10%;
3. The above parameters are typical values;

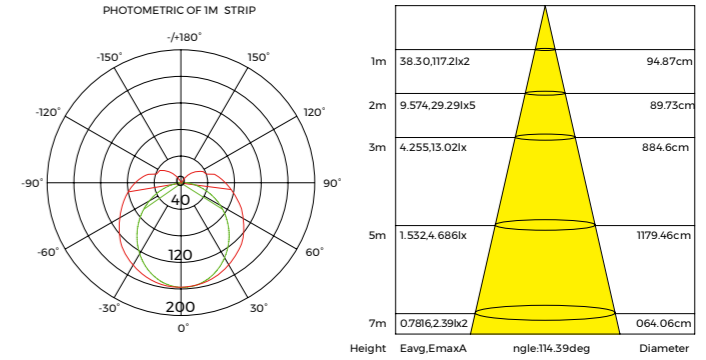

Ordering Code

Category	Series	Bending direction	Section Size	CRI	CCT	Voltage	Silk Printing	Entry Cable	Wire Type	Wire Length	Brand Code	Label Type	LED Strip Length																													
Silicone neon strip	N	Domed Neon	S	12X24mm	1224	24V	Standard	C	Dual-ends	D	PVC	N	500mm	050	Standard	C	Standard	C	5M	0500																						
																					Ra>80	8	2300K	LW	24	24	Standard	C	Dual-ends	D	PVC	N	500mm	050	Standard	C	Standard	C	5M	0500		
																					Ra>90	9	2700K	SW			Customized	S	Oneend	S	Silica	S			Package for distributors	B	Customized	S			10M	1000
																							3000K	WW			Neutral screen	N	No	X												
																							3700K	NW																		
																							5000K	DW																		
																							0	0	RGB																	

NNS1224-8LW24CSN050CC1000

NNR25 NEW

- 360° uniform round-glowing design, applicable to space decoration lighting.
- High luminous efficiency, LM80 proved.
- Silicone extrusion molding technology, IP65.
- Pendant and surface mounted are achievable.
- 3 years warranty, life span over 36000 hours.

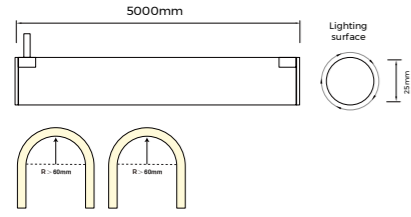

24V DC 5m REEL

Basic Parameters

Size	5000×φ25mm
Cutting unit	41.66mm
Input voltage	24VDC
Input current	0.6A/m
Typ.power	14.4W/m
Max.power	16W/m
Bend radius	>60mm

Recommended Accessories

PC Carrier	L: 1000mm, With screws	
PC Clip	L: 25mm, With screws	
End cap set	One end cap+one plug	
End cap set	One end cap+one plug	
Pendant cable	Accessories for hanging lighting	

Photo-electric Parameters

CRI	CCT	LM/m	LM/W
>80/90	2300 K	900	62
	2700 K	950	66
	3000 K	950	66
	4000 K	900	62

1. The above parameters are tested based on 1M standard products;
2. The power and luminous flux are allowed to have an error range of ±10%;
3. The above parameters are typical values;

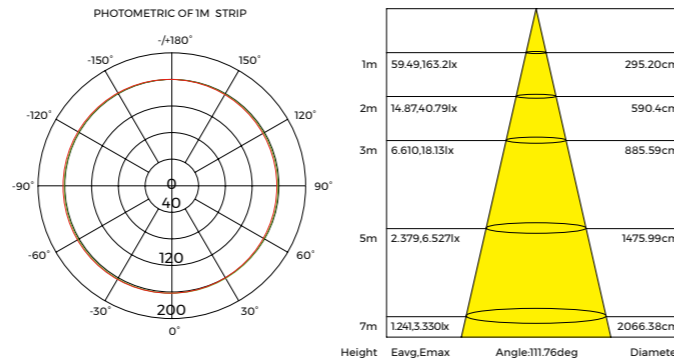

Ordering Code

Category	Series	Bending direction	Section Size	CRI	CCT	Voltage	Silk Printing	Entry Cable	Wire Type	Wire Length	Brand Code	Label Type	LED Strip Length																			
Silicone neon strip	N	Domed Neon	N	360	R	φ25mm 25	-	Ra>80	8	2300K	LW	24V 24	Standard	C	Dual-ends	D	PVC	N	500mm	050	Standard	C	Standard	C	5M	0500						
								Ra>90	9	2700K	SW	Customized	S	Oneend	S	Silica	S	Package for distributors	B	Customized	S											
										3000K	WW	Neutral screen	N	No	X																	
										4000K	NW																					
	N	N	R	25	-	8	NW	24	C	S	N	050	C	C										0500								



















NNR25-8NW24CSN050CC0500 🔍

Accessories List











End cap/plug

Model	Name	Description	Matched product	Image
AS-NTS0410GH0-EC	End cap set	Silica end cap set, with end cap, plug and clip	NTS0410	
AS-NMS0612GH0-EC	End cap set	Silica end cap set, with end cap, plug	NMS0612	
AS-NMT1312GS0-EC	End cap set	Silica end cap set, with end cap, plug	NMT1312-Plus NMT1312U	
AS-NMT1312HT0-FL AS-NMS1217HT0-FL	Soldering-free waterproof end cap	Soldering-free & waterproof connector, Soldering-free electrification, IP67 protection, outlet from the horizontal (top) direction	NMT1312-Plus NMT1312U NMS1217-Plus	
AS-NMT1312HB0-FL AS-NMS1217HB0-FL	Soldering-free waterproof end cap	Soldering-free & waterproof connector, Soldering-free electrification, IP67 protection, outlet from the bottom direction	NMT1312-Plus NMT1312U NMS1217-Plus	
AS-NMT1312HL0-FL AS-NMS1217HL0-FL	Soldering-free waterproof end cap	Soldering-free & waterproof connector, Soldering-free electrification, IP67 protection, outlet from the left direction	NMT1312-Plus NMT1312U NMS1217-Plus	
AS-NMT1312HR0-FL AS-NMS1217HR0-FL	Soldering-free waterproof end cap	Soldering-free & waterproof connector, Soldering-free electrification, IP67 protection, outlet from the right direction	NMT1312-Plus NMT1312U NMS1217-Plus	
AS-NMT1312TX0-FL AS-NMS1217TX0-FL	Soldering-free waterproof end cap	Soldering-free & waterproof connector, Soldering-free electrification, IP67 protection, non-outlet from plug	NMT1312-Plus NMT1312U NMS1217-Plus	
AS-NMT1515GH0-EC	End cap set	Silica end cap set, with end cap and plug	NMT1515	
AS-NM3D1515GH0-EC	End cap set	Silica end cap set, with end cap and plug	NM3D1515	
AS-NNS1224GH0-EC	End cap set	Silica end cap set, with end cap and plug	NNS1224	
AS-NNT1615GH0-EC	End cap set	Silica end cap set, with end cap and plug	NNT1615	
AS-NMS1217GS0-EC	End cap set	Silica end cap set, with end cap and plug	NMS1217-Plus	
AS-NTS1220GS0-EC	End cap set	Silica end cap set, with end cap and plug	NTS1220	
AS-NMS1020GS0-EC	End cap set	Silica end cap set, with end cap and plug	NMS1020	
AS-NNR25GH0-EC	End cap set	PC end cap set, with end cap and plug	NNR25	
AS-NNR25GS0-EC	End cap set	PC end cap set, with end cap and plug	NNR25	









Clip

Model	Name	Description	Matched product	Image
AS-NTS0410S-18	Fixed clip	Fixed clip, 0.3mm stainless steel, white paint, with screws	NTS0410	
AS-NMS0612A-20	Aluminum clip	Flat mounting of clip, L: 20mm, with screws	NMS0612	
AS-NMS0612A1-20	Aluminum clip	Clip of reserved outlet position, L: 20mm, with screws	NMS0612	
AS-NMS0612P-20	PC clip	Flat mounting of PC clip, L: 20mm, with screws	NMS0612	
AS-NMT1312A-25	Aluminum clip	Flat mounting of clip, L: 25mm, with screws	NMT1312-Plus NMT1312U	
AS-NMT1312A1-25	Aluminum clip	Clip of reserved outlet position, L: 25mm, with screws	NMT1312-Plus NMT1312U	
AS-NMT1515S-95	Fixed clip	Fixed clip, L: 95mm, with screws	NMT1515	
AS-NMS1217A-25	Aluminum clip	Flat mounting of clip, L: 25mm, with screws	NMS1217-Plus NNS1224	
AS-NMS1217A1-25	Aluminum clip	Clip of reserved outlet position, L: 25mm, with screws	NMS1217-Plus NNS1224	
AS-NMS1217P-25	PC clip	Flat mounting PC clip, L: 25mm, with screws.	NMS1217-Plus NNS1224	
AS-NNT1615P-25	PC clip	Flat mounting PC clip, L: 25mm, with screws	NNT1615	
AS-NNT1615A-25	Aluminum clip	Aluminium clip, flat mounting, L: 25mm, with screws	NNT1615	
AS-NTS1220A-25	Aluminum clip	Aluminium clip, flat mounting, L: 25mm, with screws	NTS1220	
AS-NMS1020A-25	Aluminum clip	Aluminium clip, flat mounting, L: 25mm, with screws	NMS1020	
AS-NTM1312P-25	PC clip	Flat mounting PC clip, L: 25mm, with screws	NMT1312-Plus NMT1312U	
AS-NNR25P-25	PC clip	Flat mounting PC clip, L: 25mm, with screws	NNR25	
AS-NMT1312MX0-FL AS-NMS1217MX0-FL	Soldering-free waterproof quick connector	End cap, soldering-free electrification, IP67 protection, soldering-free quick connector	NMT1312-Plus NMT1312U NMS1217-Plus	
AS-NMT1312MHO-FL AS-NMS1217MHO-FL	Soldering-free waterproof quick connector(with wire)	End cap, soldering-free electrification, IP67 protection, soldering-free quick connector, outlet wire length 300mm	NMT1312-Plus NMT1312U NMS1217-Plus	

Carrier

Model	Name	Description	Matched product	Image
AS-NTS0410A-1000	Aluminium carrier	Aluminium profile, flat mounting	NTS0410	
AS-NMS0612A-1000	Aluminium carrier	Flat mounting aluminum groove, L: 1000mm, with screws	NMS0612	
AS-NMS0612A1-1000	Aluminium carrier	Aluminum groove reserved outlet position, L: 1000mm, with screws	NMS0612	
AS-NMS0612P-1000	PC carrier	Flat mounting PC groove, L: 1000mm, with screws	NMS0612	
AS-NMS0612M-500	Moldable groove	Moldable groove, L: 500mm, with screws	NMS0612	
AS-NMT1515M-1000	Moldable groove	Moldable groove, L: 5000mm, with screws	NMT1515	
AS-NMT1312A-1000	Aluminium carrier	Flat mounting aluminum groove, L: 1000mm, with screws	NMT1312-Plus NMT1312U	
AS-NMT1312A1-1000	Aluminium carrier	Aluminum groove reserved outlet position, L: 1000mm, with screws	NMT1312-Plus NMT1312U	
AS-NMT1312A2-1000	Aluminum groove with reserved outlet position	Aluminum groove with reserved outlet position, L: 1000mm, with screws	NMT1312-Plus NMT1312U	
AS-NMT1312M-500	Moldable groove	Moldable groove, L: 500mm, with screws	NMT1312-Plus NMT1312U	
AS-NMT1312P-1000	PC carrier	Flat mounting PC groove, L: 1000mm, with screws	NMT1312-Plus NMT1312U	
AS-NMS1217A-1000	Aluminium carrier	Flat mounting aluminum groove, L: 1000mm, with screws	NMS1217-Plus NNS1224	
AS-NMS1217A1-1000	Aluminium carrier	Aluminum groove of reserved outlet position, L: 1000mm, with screws	NMS1217-Plus NNS1224	
AS-NMS1217A2-1000	Aluminum groove with reserved outlet position	Aluminum groove with reserved outlet position, L: 1000mm, with screws	NMS1217-Plus NNS1224	
AS-NMS1217P-1000	PC carrier	Flat mounting PC groove, L: 1000mm, with screws	NMS1217-Plus NNS1224	
AS-NMS1217M-500	Mouldable groove	Moldable groove, L: 500mm, with screws	NMS1217-Plus NNS1224	
AS-NNT1615A-1000	Aluminium carrier	Aluminum groove of reserved outlet position, L: 1000mm, with screws	NNT1615	
AS-NNT1615P-1000	PC carrier	Flat mounting PC groove, L: 1000mm, with screws	NNT1615	
AS-NNR25P-1000	PC carrier	Flat mounting PC groove, L: 1000mm, with screws	NNR25	
AS-NTS1220A-1000	Aluminium carrier	Aluminum groove of reserved outlet position, L: 1000mm, with screws	NTS1220	
AS-NMS1020A-1000	Aluminium carrier	Aluminum groove of reserved outlet position, L: 1000mm, with screws	NMS1020	



Wire cable

Model	Name	Description	Matched product	Image
AS-WS-0001	PVC wire (0.5M Φ4.5mm)	2P white, 20AWG, outer diameter 4.5mm, UL2464,300V, 80°C, L=500mm	NMS1217-Plus, NMT1312-Plus, NMT1312U, NMT1515,NNR25	
AS-WS-0002	PVC wire (2M Φ4.5mm)	2P white, 20AWG, outer diameter 4.5mm, UL2464,300V, 80°C, L=2000mm	NMS1217-Plus, NMT1312-Plus, NMT1312U, NMT1515,NNR25	
AS-WS-0003	PVC wire (0.5MΦ4.5mm)	4P white (red & green & blue & black), 20AWG, outer diameter 4.5mm, UL2464,300V, 80°C, L=500mm	NMS1217-Plus, NMT1312-Plus, NMT1515	
AS-WS-0004	PVC wire (2M Φ4.5mm)	4P white (red & green & blue & black), 20AWG, outer diameter 4.5mm, UL2464,300V, 80°C, L=2000mm	NMS1217-Plus, NMT1312-Plus, NMT1515	
AS-WS-0005	PVC wire (0.5M Φ4.0mm)	2P white, 20AWG, outer diameter 4.0mm, UL2464,300V, 80°C, L=500mm	NMS0612	
AS-WS-0006	PVC wire (2M Φ4.0mm)	2P white, 20AWG, outer diameter 4.0mm, UL2464,300V, 80°C, L=2000mm	NMS0612	
AS-WS-0007	PVC wire (0.5M Φ6.0mm)	2P white, 18AWG, outer diameter 6mm, UL2464,300V, 80°C, L=500mm	NNT1615/NMS1020	
AS-WS-0008	PVC wire (2M Φ6.0mm)	2P white, 18AWG, outer diameter 6mm, UL2464,300V, 80°C, L=2000mm	NNT1615/NMS1020	
AS-WS-0009	Gray wire (0.5M)	2P gray, 20AWG, L=500mm	NTS0410	
AS-WS-0010	Gray wire (2M)	2P gray, 20AWG, L=2000mm	NTS0410	
AS-WS-0011	4P PVC wire (0.5M)	4P white, 20AWG, outer diameter 6mm, UL2464,300V, 80°C, L=500mm	NNT1615RGB	
AS-WS-0012	4P PVC wire (2M)	4P white, 20AWG, outer diameter 6mm, UL2464,300V, 80°C, L=2000mm	NNT1615RGB	
AS-WS-0013	5P PVC wire (0.5M)	5P white, 22AWG, L=500mm	NMS1217-Plus, NMT1312-Plus	
AS-WS-0014	5P PVC wire (2M)	5P white, 22AWG, L=2000mm	NMS1217-Plus, NMT1312-Plus	

Accessories

Model	Name	Description	Matched product	Image
PN-SA2	Pendant cable	Accessories for hanging lifting	NNR25	

Waterproof connector

Model	Name	Description	Matched product	Image
AS-FC-0001	2PIN IP68 waterproof connector	2P wiring method: screw crimping, IP68 waterproof connector	White color strip	
AS-FC-0002	3PIN IP68 waterproof connector	3P wiring method: screw crimping, IP68 waterproof connector	Adjustable CCT, digital neon strip	
AS-FC-0003	4PIN IP68 waterproof connector	4P wiring method: screw crimping, IP68 waterproof connector	RGB neon strip	

Glue

Model	Name	Description	Matched product	Image
AS-PC-0002	Neutral glue	Neutral glue, 10ml/pcs, suitable for silicone neon strip and silicone extrusion strip	All models	